

জাতীয় শিক্ষাক্রম ২০১২

গণিত

ষষ্ঠ-দশম শ্রেণি

ডাক্তার গণিত

নবম-দশম শ্রেণি



জাতীয় শিক্ষাক্রম ও পাঠ্যপুস্তক বোর্ড

জাতীয় শিক্ষাক্রম ২০১২

গণিত

ষষ্ঠ-দশম শ্রেণি

উচ্চতর গণিত

নবম-দশম শ্রেণি

জাতীয় শিক্ষাক্রম ও পাঠ্যপুস্তক বোর্ড

জাতীয় শিক্ষাক্রম ২০১২

উন্নয়ন ও তত্ত্বাবধান



জাতীয় শিক্ষাক্রম ও পাঠ্যপুস্তক বোর্ড

৬৯-৭০ মতিঝিল বাণিজ্যিক এলাকা, ঢাকা ১০০০।

আর্থিক ও কারিগরি সহযোগিতা



সেক্টরাল এডুকেশন সেক্টর ডেভেলপমেন্ট প্রজেক্ট

মাধ্যমিক ও উচ্চশিক্ষা অধিদপ্তর, শিক্ষাভবন, ঢাকা ১০০০।

প্রকাশকাল
ডিসেম্বর ২০১২

মুদ্রণ : নাহিদ এড. এন্ড প্রিন্টিং, ১১৩/১১৪ নয়ানস্টন, মতিঝিল, ঢাকা- ১০০০

জাতীয় শিক্ষাক্রম ২০১২

մԱՐԿԻ

μg	ՎԵԼ զԵ՛՛	ԸՓՆ ԲԻՒՒ
1.	գԼԵՍ	i
2.	մՔԵՆ	1
3.	ՎԿՅՎՄԳ ԸԲԱԳԻԽ ԻՏՆԻՅՔԶՆ	1
4.	ՎԿՅՎՄԳ ԸԲԱԳԻԽ ԱԲՅՆԶ ԳԳՎԵ	2
5.	ՎԿՅՎՄԳ ԸԲԱԳԻԽ ԱԲՅՆԶ ԸՌԿԵՆ	2
6.	ՐԻԶԻՔ ՎԿՅՎՄԳ 2012 ԳԻՒԵՒԿՕՒ	7
7.	ՎԿՅՎՄԳԻ ԻՋԵՒԼՎ	7
8.	ՎԿԼԵ ԻԿԼՎԻԽՆ ԸՔՈՒԶ Ի ԻԿՏԿԵ	10
9.	ՎԿՅՎՄԳՆ ԴՅՈՒՄՆԵՐ	15
10.	ՎԿՅՎՄԳ ԸԲԱԳԻԽ ՄՏՈՒԿՕ ԿՐԿՆԱԿ	19
11.	ՄՎԶ ՎԿՅՎՄԳ	23
12.	ԸՐՔԻԻ ՄՎԶ ՎԿՅՎՄԳ	115-140

1. mPbv

1.1 hē_wPZ ce@wi Kí bv cŷqb Ges Gi mǝzev_levq̄tbi Dci wbfP K̄ti th̄tKv̄t̄bv Kvh̄p̄t̄gi mdj Zv| w̄K̄ŷv Kvh̄p̄t̄gi Gifc ce@wi Kí bvB w̄K̄ŷvμg| w̄K̄ŷv_ŷP̄ i AvM̄b, c̄ēYZv, mvg_©, AwfÁZv I w̄K̄Lb Pwn`vi mvt_ Ges mgvR, t`k I AvšR̄ZK cwi w̄w̄Z wetePbvq̄ t̄iL cŷvZ nq w̄b̄w̄̄ w̄K̄ŷvμg| t̄K, t̄Kb, Kx, w̄K̄f̄v̄te, Kvi mn̄th̄w̄MZvq, Kx w̄ t̄q, t̄Kv_vq, KZ mgq āti w̄K̄L̄te Ges hv w̄K̄Lj w̄K̄f̄v̄te Zv hvPvB Kiv hv̄te Gme c̄ōk̄ē DĒi w̄K̄ŷvμtg _v̄t̄K| w̄K̄ŷv̄i j`ŷ, D̄t̄i k̄, w̄K̄Lbdj, w̄elqē, w̄K̄Lb-t̄kL̄v̄t̄bv Kvh̄p̄g I ḡj`vq̄b w̄b̄t`Rbv-GmeB w̄K̄ŷvμt̄gi c̄ōZc̄v` w̄elq| w̄K̄ŷvμt̄gi w̄f̄w̄Ēt̄ZB cŷvZ nq c̄V`c̄j̄K I Ab`v̄b` w̄K̄Lb-t̄kL̄v̄t̄bv mvgM̄ Ges cwi Pw̄j Z nq w̄K̄Lb-t̄kL̄v̄t̄bv Kvh̄p̄g| Gme cŷq̄t̄bi w̄b̄t`Rbv| _v̄t̄K w̄K̄ŷvμt̄g| w̄K̄ŷvμt̄ḡt̄K w̄K̄ŷv Kvh̄p̄g ev_levq̄t̄bi bxj -bK̄kv ejv n̄t̄q _v̄t̄K|

1.2 w̄K̄ŷvμg GKw̄ Pj gvb c̄ōμq̄v| G c̄ōμq̄vq avivew̄Nk cwi ex̄ŷt̄ŷi gra`tg Pj gvb w̄K̄ŷvμt̄gi mej Zv`p̄j Zv I Dc̄th̄w̄MZv w̄b̄ŷ̄q̄ Kiv nq| mḡt̄q̄i mvt_ mgv̄t̄Ri cwi eZ̄b̄ NŪt̄Q, ZvOrov Avb-w̄eAvb I c̄h̄ŷ̄i`z̄ cwi eZ̄b̄ n̄t̄Q| Gm̄t̄ei dt̄j w̄K̄Lb Pwn`v̄l cwi eZ̄Z̄ n̄t̄Q| G Rb` c̄ōq̄vRbxq̄ cwi gv̄R̄b̄ I bevq̄t̄bi gra`tg w̄K̄ŷvμg h̄ŷM̄c̄th̄w̄M̄x ivLv Avek`K| Avevi Ggb mgq Av̄tm̄ hLb c̄ŷīv̄t̄bv w̄K̄ŷvμg cwi gv̄R̄b̄ K̄ti mḡt̄q̄i Pwn`v̄ c̄ŷY m̄e nq bv, ZLb bZb w̄K̄ŷvμg cŷq̄b Kīt̄Z nq| RvZxq̄ w̄K̄ŷv̄b̄w̄Z ev_levq̄t̄bi Rb`I bZb w̄K̄ŷvμg Db̄q̄b Kīt̄Z nq| G cwi t̄c̄ŷ̄t̄Z RvZxq̄ w̄K̄ŷvμg 2012 cŷq̄t̄bi c`t̄ŷ̄c̄ M̄b̄Y Kiv n̄t̄q̄t̄Q|

2. w̄K̄ŷvμg Db̄q̄t̄bi th̄ŷ̄K̄Zv

2.1 gra`w̄gK̄ t̄ŷi eZ̄ŷ̄b̄ w̄K̄ŷvμg 1995 m̄t̄j cŷvZ| Gici `x̄N̄mḡt̄q̄ RvZxq̄ I AvšR̄ZK cwi gĒj̄ mvgw̄RK, mis`w̄ZK, A_ŷ̄w̄ZK I ivR̄ŷ̄w̄ZK w̄ef̄b̄ēt̄ŷ̄t̄ w̄et̄kl̄ K̄ti Avb-w̄eAvb, Z` I th̄w̄th̄w̄M̄ c̄h̄ŷ̄i`ŷ̄i t̄ŷ̄t̄ e`v̄cK̄ cwi eZ̄b̄ N̄t̄Ūt̄Q| cwi eZ̄ŷ̄bi mvt_ mvt_ w̄K̄ŷv_ŷ̄i w̄K̄Lb-Pwn`v̄`z̄ cwi eZ̄Z̄ n̄t̄Q| G Pwn`v̄b̄h̄v̄q̄x w̄K̄ŷv̄t̄K h̄ŷM̄c̄th̄w̄M̄x Kivi Rb` w̄K̄ŷvμg Db̄q̄b Acwi w̄h̄ŷ̄t̄q̄ `w̄ōt̄q̄t̄Q|

2.2 gra`w̄gK̄ t̄ŷi c̄ŷ̄j̄ Z w̄K̄ŷvμt̄gi Dci ŷ̄va`w̄gK̄ t̄ŷi w̄K̄ŷvμg ḡj`vq̄b I Pwn`v̄ w̄b̄īf̄c̄ŷ̄Ō k̄x̄l̄ R̄ cwi Pw̄j Z M̄t̄el̄Yvi djv̄d̄t̄j̄ w̄K̄ŷvμt̄gi At̄bK̄ `p̄j̄Zv, Am̄ŷ̄w̄Z I mgm̄v̄ w̄P̄w̄j̄Z n̄t̄q̄t̄Q| G w̄K̄ŷvμg Av̄Zḡv̄t̄q̄ ZĒj̄ I Z` m̄sej̄ Z hv

w̄K̄ŷv_ŷ̄K̄ ḡj` Kīt̄Z Dr̄m̄w̄n̄Z K̄ti| c̄ŷ̄j̄ Z w̄K̄ŷvμt̄g Ab̄m̄Ūvb, mgm̄v̄ mgv̄at̄bi th̄w̄M̄Zv AR̄b̄, n̄t̄Z-Kj̄ t̄ḡ Kiv R̄ti t̄kLvi Ges m̄R̄bk̄x̄j̄ I D̄m̄ŷ̄ēbx̄ ŷ̄ŷ̄Zv w̄eK̄v̄t̄ki m̄th̄w̄M̄ m̄w̄ḡZ| w̄K̄ŷv_ŷ̄i`b̄w̄ZK I gvb̄eK̄ ŷ̄Yveij̄ i w̄eK̄v̄t̄ki m̄th̄w̄M̄ K̄g| c̄ōq̄vRbxq̄ w̄elq̄ Ges w̄elqē` th̄gb- Z` I th̄w̄th̄w̄M̄ c̄h̄ŷ̄i`ŷ̄i, R̄j̄ ev̄q̄j̄ cwi eZ̄b̄ I KiYxq̄, eq̄tm̄ŪK̄j̄ I c̄R̄bb̄ `ŷ̄, R̄j̄ w̄b̄ w̄b̄iv̄c̄Ēv̄ BZ`w̄i c̄ōZdj̄b̄ L̄p̄B m̄w̄ḡZ| ZvOrov gv̄Z̄f̄v̄lv̄ ev̄sj̄v̄ Ges AvšR̄ZK̄ f̄lv̄ B̄st̄īw̄R̄ w̄K̄Lb-t̄kL̄v̄t̄b̄vi t̄ŷ̄t̄ t̄k̄v̄b̄, ej̄v, cov, t̄j̄ Lv Gme `ŷ̄ŷ̄Zv w̄K̄L̄t̄bi Rb` w̄K̄ŷvμt̄g ŷ̄īz̄j̄ c̄lv̄b̄ Kiv n̄t̄j̄ I ev_levq̄t̄b̄ Ḡŷ̄t̄j̄v̄ h_vh_ ŷ̄īz̄j̄ c̄vq̄ w̄b̄| w̄K̄ŷv_ŷ̄i` īt̄K̄ K̄ḡŷ̄x̄ Kivi t̄ŷ̄t̄ w̄K̄ŷvμt̄gi Ae`v̄b̄ m̄t̄š̄īl̄ R̄bK̄ b̄q̄| bevq̄bK̄Z w̄K̄ŷvμt̄gi Gme m̄x̄ḡv̄x̄Zv K̄w̄l̄t̄q̄ DV̄vi c̄ōP̄ov̄ t̄b̄l̄ q̄v̄ n̄t̄q̄t̄Q|

2.3 RvZxq̄ w̄K̄ŷv̄b̄w̄Z 2010 ev̄sj̄v̄t̄ t̄ki w̄K̄ŷv̄t̄ŷ̄t̄i GKw̄ gv̄Bj̄ dj̄K| RvZxq̄ w̄K̄ŷv̄b̄w̄Z 2010 Ab̄m̄v̄t̄i w̄K̄ŷv̄i gra`tg h̄ŷM̄c̄th̄w̄M̄x R̄bk̄w̄³ Db̄q̄t̄bi Rb` c̄ōq̄vRb̄ w̄K̄ŷvμt̄gi Db̄q̄b Ges Gi h_vh_ ev_levq̄b| RvZxq̄ w̄K̄ŷv̄b̄w̄Z 2010 Gi ev_levq̄t̄bi m̄ēŷ̄aK̄ ŷ̄īz̄c̄ŷ̄c̄`t̄ŷ̄c̄ n̄t̄Q G w̄K̄ŷv̄b̄w̄Z Ab̄m̄v̄t̄i w̄K̄ŷv̄e`vi c̄ēZ̄b̄ Ges Gi Rb` c̄ōq̄vRb̄ t̄m̄ Ab̄m̄v̄t̄i w̄K̄ŷvμg Db̄q̄b|

2.4 ev̄sj̄v̄t̄ t̄ki īf̄c̄K̄i 2021 Gi j`ŷ` n̄t̄Q w̄w̄īR̄Ūj̄ ev̄sj̄v̄t̄ k̄ M̄t̄ō t̄Z̄j̄v̄ Ges t̄`k̄t̄K̄ ga`ḡ Av̄t̄q̄i t̄`t̄k̄ cwi YZ̄ Kiv| w̄w̄īR̄Ūj̄ ev̄sj̄v̄t̄ k̄ Mov Ges ga`ḡ Av̄t̄q̄i t̄`t̄k̄ cwi YZ̄ Kivi c̄āvb̄ D̄c̄v̄q̄ n̄t̄Q w̄K̄ŷv̄i gra`tg h̄t̄_vch̄ŷ̄ R̄bk̄w̄³ m̄j̄ō Kiv| Avi w̄K̄ŷv̄i gra`tg Zv Kivi Rb` c̄ōq̄vRb̄ Dc̄th̄w̄M̄x w̄K̄ŷvμg|

2.5 GK̄w̄esk̄ kZv̄āxi w̄K̄ŷv̄i Rb` M̄w̄Z AvšR̄ZK̄ w̄K̄ŷv̄i K̄uḡk̄b̄ w̄īt̄c̄v̄L̄ēr̄n̄ḡ: The Treasure Within' G gra`w̄gK̄ w̄K̄ŷv̄t̄K̄ R̄x̄ēt̄b̄ c̄ōēk̄ōvi 'gateway to life' w̄n̄m̄v̄te w̄P̄w̄j̄Z̄ Kiv n̄t̄q̄t̄Q| Gi A_©K̄ḡR̄x̄ēt̄b̄ c̄ōēt̄ki c̄ōq̄vRbxq̄ th̄w̄M̄Zv gra`w̄gK̄ w̄K̄ŷv̄i gra`tg AR̄b̄| G th̄w̄M̄Zv AR̄b̄i Rb` c̄ōZ̄te`t̄b̄ w̄K̄ŷv̄i P̄vīw̄L̄ t̄ŷ̄c̄w̄P̄w̄j̄Z̄ Kiv n̄t̄q̄t̄Q| t̄ŷ̄t̄nḡ n̄t̄Q-R̄iv̄bi Rb` t̄kL̄v, Kiv R̄ti Rb` t̄kL̄v, w̄ḡt̄j̄ w̄ḡt̄k̄_v̄K̄vi Rb` t̄kL̄v Ges w̄eK̄w̄k̄Z̄ n̄l̄ q̄vi Rb` t̄kL̄v| Gme t̄ŷ̄c̄ev_levq̄t̄bi gra`tg GK̄w̄esk̄ kZv̄āxi Dc̄th̄w̄M̄x R̄bk̄w̄³ m̄j̄ōi Rb` c̄ōq̄vRb̄ t̄m̄ Ab̄m̄v̄t̄i w̄K̄ŷvμg Db̄q̄b|

- 4.1 **Ae⁻vi wetk^oY**
- 4.1.1 **gva⁻vgK ⁻tii c^ohuj Z uk^ovlvug ch^ouj vPbv**
 GmBGm^oWici uk^ovlvug wetk^ol Ae⁻ 2008 mt^ouj gva⁻vgK ⁻tii (ubg^ogva⁻vgK I gva⁻vgK) uk^ovlvug ch^ouj vPbv K^otib| th^oSw^oK ch^ouj vPbv gva⁻tg uk^ovlvut^ogi T^oau^o-weP^oiz Ges uk^ovlv^o ⁻ti uk^oLb P^owin^o v c^oit^oY uk^ovlvut^ogi Dc^oth^oW^oM^oZv hvP^ovB Kiv nq| GB ch^ouj vPbv dj vdj bZb uk^ovlvug Db^oqt^ob we^oteP^obvq ivLv nq|
- 4.1.2 **c^ohuj Z uk^ovlvut^ogi gj⁻vqb**
 GmBGm^oWici uk^ovlvug wetk^ol AMY ^ogva⁻vgK ⁻tii uk^ovlvug gj⁻vqb I P^owin^o v **ubi^ofcY mgr^ovlv 2010^o** k^ol R GK^oW M^otel Yv c^ovi P^ovj bv K^otib| G mgr^ovi gva⁻tg uk^ovlvut^ogi mej I ⁻ej w^oK, ev⁻evqt^obi c^oZe^oUKZv I c^ovi gr^oR^obi t^oq^ol m^ogn vP^ovZ Ges uk^ovlv^o ⁻ti uk^oLb-P^owin^o v ubi^ofcY Kiv nq|
- 4.1.3 **RvZ^oq uk^ovlv^oWZ 2010**
 RvZ^oq uk^ovlv^oWZ 2010-G D^otj^oWZ uk^ovlv m^osv^ošl b^oWZm^ogn wetk^ol K^oti gva⁻vgK uk^ovlv m^oau^oWZ av^ovm^ogn ch^ouj vPbv K^oti bZb uk^ovlvug Db^oqt^obi w^oFZ ⁻Z^ovi Kiv nq| uk^ovlv^oWZi w^oF^oEt^oZB c^ohuj Z m^oKj av^oivi (m^ovaiY, g^ov^oimv, B^ost^oivR) uk^ovlv^oWZ uk^ovlv^oW^o ch^ouj ch^ošl m^og^ošZ I GK^oglx uk^ovlvut^ogi Av^ol Z^oq A^oš^of^o Kivi c^o-t^oq^ol t^obl qv nq| G e⁻vq me ai^ot^obi uk^ovlv c^oZ^ovt^ob c^og t^o-t^oK A^oog tk^oiv ch^ošl GK^oB uk^ovlvug Ab^omv^oti uk^ovlv K^ovh^oeg c^ovi P^ovj Z n^ote|
- 4.1.4 **Av^ošR^oWZK ch^ouj uk^ovlvug ch^ouj vPbv**
 m^ogm^ovg^oqK wetk^ol ube^oWZ K^oqK^oW t^o-t^oki- f^ovi Z, k^otj^o v^o, g^ovj^o t^oq^oq^o, w^ol^ov^ouj, A^ot^o-t^oq^o (A^ol^oivR^o), h^oš^oivR^o (A^ol^oivR^o) Ges K^oviW^ovi (A^ol^oivR^o) uk^ovlvug ch^ouj vPbv Kiv nq| Gme t^o-t^oki uk^ovlv^o e⁻vi wetk^ol K^oti uk^ovlvut^ogi wetk^ol w^o Km^ogn ch^ouj vPbv K^oti ev^osj v^o-t^oki c^ovi w^o-WZ^o G^oti Dc^oth^oW^oM^oZv hvP^ovB Kiv nq|
- 4.1.5 **c^oW^oZK c^oZ^ote⁻b, c^oU I gZ^ovgZ ch^ouj vPbv**
 t^o-t^oki-wet^o-t^oki c^oW^oZK uk^ovlv m^oau^oWZ wetk^ol K^oti uk^ovlvug w^olqK c^oZ^ote⁻b, c^oU I gZ^ovgZ ch^ouj vPbv Kiv nq| G^o-t^oji v^o g^o-t^o D^otj^oW^o K^oqK^oW n^o-t^oQ-GK^owesk kZ^ov^oxi uk^ovlv m^oau^oWZ Av^ošR^oWZK uk^ovlv K^oig^okt^obi c^oZ^ote⁻b UNESCO (1996) ^oLearning: The Treasure Within; O'Neill, Geraldine (2010) 'Programme Design: Overview of Curriculum Models'; Marsh, C.J (1997) 'Perspective Key Concepts for Understanding Curriculum'; Sheehan, John

(1986) Curriculum Models: Product versus Process, Smith, P.L (1993) Instructional Design, Macmillan; RvZ^oq uk^ovlvug I c^ov^o c^oY^o K teW^oW^oc^ovi P^ovj Z (2012) ubg^ogva⁻vgK, gva⁻vgK I D^ogva⁻vgK ch^ouj uk^ovlvug, uk^ovlvug c^oW^oY uk^ovlvug I c^ov^o c^oY^o K t^oR^ovi m^oste⁻ bk^oxj Zv ch^ouj vPbv k^ol R c^oZ^ote⁻b, Rj ev^oq- c^ovi eZ^o I ⁻th^oW, Z^ovgvK ubq^oš^o, UNICEF (2009) c^ovi P^ovj Z ^oR^oieb ⁻q^oZ^ow^of^oW^oE^oK uk^ovlv^o|

ZvQ^ovov ev^osj v^o-t^oki w^oef^ob^oe c^oK^oi, miK^ovi I t^oemiK^ovi c^oZ^oov^o Ges m^o-v uk^ovlvut^og A^oš^of^o i R^o 31^oW c^oZ^ote⁻b Rgv t^o-q| Gme c^oZ^ote⁻b ch^ouj vPbv K^oti m^osk^oo^o w^ol^oq c^oW^oqR^ob^oq c^oW^oW^oZK w^olq^o- m^ost^oh^ovR^ot^obi e⁻v^o t^obl qv nq| 31^oW c^oZ^ote⁻ t^obi g^o-t^o D^otj^oW^o K^oqK^oW n^o-t^oQ- Rj ev^oq c^ovi eZ^o, Z^o- c^oW^oš^o Av^oW^ovi, Lv^o-c^oq^o, c^oR^obb ⁻v^o, GBPA^ov^oW^of^o-GBW^om, wetk^ol P^owin^o v m^o-u^ob^ow^oki BZ^o-w^o |

4.2 **uk^ovlvut^ogi i^octiLv c^oq^ob**

Ae⁻vi wetk^oY t^o-t^oK j^oä Av^of^oAv^o I djvd^ot^oji w^oF^oEt^oZ GmBGm^oWici uk^ovlvug wetk^ol Ae⁻ RvZ^oq c^ovgk^oKi ub^o-t^o R^obvq uk^ovlvug Db^oqt^obi b^oWZg^ov Ges w^oef^ob^oe ch^ouj uk^ovlv K^ovh^oeg mgr^ovK^oiv^o i uk^ovlv AM^ohiY c^oev^o vP^ol w^oaf^oY K^oti b| Gm^otei D^oci w^oF^oEt^o K^oti uk^ovlvut^ogi i^octiLv c^oq^ob Kiv nq|

4.2.1 **uk^ovlvug Db^oqt^obi b^oWZg^ov**

- g^onvb f^oiv Av^o-v^ojb I g^ov^oh^ot^ox^o i t^oPZ^obv Ges Am^ov^oc^oW^oqK gj⁻ter^otai w^oF^oEt^oZ t^o-k^ot^och^o w^oK^ovt^oki m^oth^oW m^ojo
- ^oW^oZKZv I g^ovb^ow^oK gj⁻ter^ota w^oK^ovt^oki D^oci ^oi^oaz^oi c^olvb
- Ab^oym^oU^ormv, m^oR^obk^oxj I D^oW^oebx q^olgZv ev^ox^o i m^oth^oW c^olvb
- w^oAv^obg^o-t^o I K^og^oglx Kivi D^oci ^oi^oaz^oi Av^oivc
- Av^oW^oK ch^ouj^o e⁻env^oti i th^oW^o Zv AR^obi m^oth^oW m^ojo
- Z^ow^oEt^o Av^ot^obi m^ot^o- ev^o-eg^olx I c^oW^oq^oM^oglx uk^ovlv i m^oth^oW ev^ox
- R^oieb^o q^oZv AR^obi m^oth^oW m^ojo
- me ai^ot^obi ^oelg^o Aem^ovt^obi j^o-t^oq^o g^ov^obe^oW^ovt^o i D^oci ^oi^oaz^oi c^olvb
- w^okl^oqt^obi P^owin^o v Ab^oym^oti g^ov^obe^oW^o m^ojo i D^oci ^oi^oaz^oi c^olvb

4.4 ակրվյալ Dբադի նեմբաժնի Kվիբ

չիբ	Kվիբ	Dբաբ/ժիբKվիբ
1. Ae֊vi նեթկիY	1.1 gva֊ngK ֊իi շիj Z ակրվյալ շիj vPbv 1.2 gva֊ngK ֊իi ակրվյալ gj֊vqb I Pwn֊v նիբիY mgv֊lv 2010 շի Pvj bv 1.3 RvZxq ակրվյալ 1995-96 նեթկիY 1.4 AvՏRՊZK շիբի ակրվյալ շիj vPbv 1.5 շիմիK շիZի֊b, շիՍ I gZvgZ շիj vPbv	1.1 GmBGmMվici ակրվյալ նեթկի Áe֊֊ 1.2 GmBGmMվici ակրվյալ նեթկի Áe֊֊ 1.3 GmBGmMվici ակրվյալ նեթկի Áe֊֊ 1.4 GmBGmMվici ակրվյալ նեթկի Áe֊֊ Ges RvZxq ակրվյալ շիj vPbv 1.5 GmBGmMվici ակրվյալ նեթկի Áe֊֊ Ges RvZxq ակրվյալ շիj vPbv
2. ակրվյալի իբի Lv շիբ	2.1 ակրվյալ Dբադի նեթկի Y 2.2 ակրվյալ Kվիբ mgv֊lv շի֊i AMիiY շիմի Pի շիբ 2.3 ակրվյալի շիբ Lv շիբ	2.1 ակրվյալ շիj vPbv նեթկի Áe֊֊ GmBGmMվici ակրվյալ նեթկի Áe֊֊ 2.2 ակրվյալ շիj vPbv նեթկի Áe֊֊ GmBGmMվici ակրվյալ նեթկի Áe֊֊ 2.3.1 ակրվյալ շիj vPbv նեթկի Áe֊֊ GmBGmMվici ակրվյալ նեթկի Áe֊֊ 2.3.2 Պ RvZxq նեթկի AskMիYKվիբ

չիբ	Kվիբ	Dբաբ/ժիբKվիբ
3. նեթկի ակրվյալ Dբադ	3.1. ակրվյալ Dբադի Dci նեթկի շիj vPbv 3.2. նեթկի ակրվյալ Dբադ	3.1. ակրվյալ շիj vPbv I tUKնK֊vj Kվիբ 3.3.1 ակրվյալ նեթկի Á, նեթկի նեթկի Á, AvFÁ շիj vPbv նեթկի Á, GmBGmMվici նեթկի ÁMիYi mgՏq MվZ նեթկի ÁE֊֊ ակրվյալ Dբադ Kվիբ, նեթկի RvZxq RvZxq ակրվյալ շիj vPbv 3.3.2 նեթկի Kգրվյալ AskMիYKվիբ նեթկի նեթկի I GmBGmMվici ակրվյալ նեթկի ÁE֊֊ 3.3.3 tUKնK֊vj Kվիբ
4. ակրվյալի mgՏq նեթկի I Abթv֊b	4.1. ակրվյալի mgv֊lv շի֊i Ask֊Zvi I mKj Astki mgՏq RvZxq ակրվյալ 2012 շի֊vb Ges 4.2. ակրվյալ Abթv֊b	4.1.1 ակրվյալ շիj vPbv I GmBGmMվici ակրվյալ նեթկի ÁE֊֊ 4.1.2 tUKնK֊vj Kվիբ 4.1.3 tFւS Kվիբ 4.1.4 շիj vPbv Kվիբ 4.1.5 GmBGmMվici 4.2 RvZxq ակրվյալ mgՏq Kվիբ

6.3 მრავიY უკვლავი ავივი ბეგ-`kg tkWi ველq-KvWtgv, ბაქ I მგე eEb

ველqი აიბ	ველq	ციქვი ბაქ	მგე eEb (Kwm wci qW)		
			მვბwnK	მვგუqK	ემლ R
Avenk`K	1. evsj v	200	5	80	160
	2. Bsṭi wR	200	5	80	160
	3. MvYZ	100	4	64	128
	4. ag ^q `bwZK უკვლავი (Bmj vj I `bwZK უკვლავი/ wv` p ^q ^q `bwZK უკვლავი/ wL ^q ag ^q `bwZK უკვლავი/ te ^s ag ^q `bwZK უკვლავი)	100	2	32	64
	5. Z_ I thw ^q thw ^q c ^q	50	2	32	64
	6. K`wi qvi უკვლავი	50	1	16	32
	7. kvixii K უკვლავი, `r`weAvb I tLj vaj v	100	2	32	64
	ტgvU	800	21	336	672
kvLwfv^q E^q ველq					
weAvb kvLvi Rb` Avenk`K ველq	8. c`v_ weAvb	100	3	54	108
	9. i m ^q b	100	3	54	108
	10. RxweAvb/D`Pzi MvYZ	100	3	54	108
	11. evsj vt`k I wek ^q w ^q Pq	100	3	54	108
	12. RxweAvb/D`Pzi MvYZ/ ^q ^q b ^q Mv ^q xi fvl v I ms`wZ/KwL უკვლავი/ Mv ^q weAvb/ f ^q Mj I cwi tek/ Pvi a I Kvi akj v/ msMvZ/te ^q wK tUW/ kvi xii K უკვლავი I μ ^q xv*	100	3	54	108
მე^q gvU	1300	36	606	1212	
e`emvq უკვლავი Rb` Avenk`K ველq	8. e`emvq D ^q `wM	100	3	54	108
	9. wmw ^q weAvb	100	3	54	108
	10. wdb`vY I e`isuk ^s	100	3	54	108
	11. weAvb	100	3	54	108

ველqი აიბ	ველq	ციქვი ბაქ	მგე eEb (Kwm wci qW)		
			მვბwnK	მვგუqK	ემლ R
e`emvq უკვლავი Rb` Hw ^q QK ველq (GKwU tbi qv hvte)	12. f ^q Mj I cwi tek/ evsj vt`k I wek ^q w ^q Pq/ KwL უკვლავი/Mv ^q weAvb/ ^q ^q b ^q Mv ^q xi fvl v I ms`wZ/Pvi a I Kvi akj v/ msMvZ/te ^q wK tUW	100	3	54	108
	მე^q gvU	1300	36	606	1212
gvbweK kvLvi Rb` Avenk`K ველq	7. evsj vt`k I BvZnm I wek ^q w ^q Zv	100	3	54	108
	9. f ^q Mj I cwi tek	100	3	54	108
	10. A_ ^q wZ/tcSi bwZ I bvMvi KZv	100	3	54	108
	11. weAvb	100	3	54	108
gvbweK kvLvi Hw ^q QK ველq (GKwU tbcv hvte)	12. A_ ^q wZ/tcSi bwZ I bvMvi KZv/Pvi a I Kvi akj v/KwL უკვლავი /Mv ^q weAvb/ ^q ^q b ^q Mv ^q xi fvl v I ms`wZ/ Avi we/ms`Z/cw ^q j / msMvZ/te ^q wK tUW /kvi xii K უკვლავი I μ ^q xv*	100	3	54	108
	მე^q gvU	1300	36	606	1212

`^q de`:

- > weAvb, gvbweK I e`emvq უკვლავი kvLvi ntZ th^q kv^q tvn GKwU kvLvi wbe^q P^q b K^q i wbe^q PZ kvLvi Avenk`K ველq mgn w^q tZ nte |
- > მ^q b^q tvn ^q w` b `w^q bK ^q w^q wci qW Kwm nte |
- > wci q^q tWi e`w^q b I Ab`v^q ველq I ^q t^q t^q K A^q g tkWi Abj^q c nte |
- * kvi xii K უკვლავი I μ^q xv ველq w^q i ayevsj vt`k μ^q xv უკვლავი c^q Z^q w^q tbi weAvb kvLvi I gvbweK kvLvi უკვლავი Hw^q QK ველq wmw^q te w^q tZ cwi te |

7. **ukLb-tkLvfbv c×wZ I tkSkj**

ukŋlvutgi mǝzev-ŋvqtbi gva'tg ukŋlv_ŋ ukLb wbuðZKiY A_ŋ ukLbdj ARB cāvbZ `ŋU weltaqi Dci wbfŋkxj | meipŋq ,iažcYŋ nŋ'Q tkāYukŋŋiKi mmuq mnŋhvMZV I hŋ_vchjŋ ukLb-tkLvfbv c×wZ I tkSkj i mǝycŋŋm Ges wðZxquU nŋ'Q gvbmsZ cW'cj K I Ab'vb' ukŋŋvcKiŋYi mWVK e'envi | Dfŋ tŋŋŋB ukŋŋiKi fvgkv AZ'sl ,iažcYŋ GK K_vq ukŋlv_ŋ ukLb wbuðZKiŋYi tŋŋŋ ukŋŋiKi tŋŋ DEg Avi ukQyŋB | GLvŋ wtkl fŋte DŋŋL' th, AŋbK KwB I RuUj KvR hv Kivi Rb' AŋbK kŋ I mgq cŋŋRb Zv hŋ_vwPZ c×wZ I tkSkj cŋŋŋM mnŋR I Kg mgŋ mWVKfŋte mēubēKiv mē | ukŋlv_ŋ ukLb i tŋŋŋ I G wbgq cŋŋhR' | ukŋŋK ce'cŋwZ wŋŋ Kg cwiŋŋ Ges AŋcŋŋKZ Kg mgŋ hŋ_vwPZ c×wZ I tkSkj cŋŋŋM ukŋlv_ŋ ukLbdj ARB wbuðZ KiŋZ cvŋb |

7.1 **ukŋlv_ŋ ukLb wbuðZ Kivi weltaqi KŋqKuU K_v**

7.1.1 ukLb-tkLvfbv cŋŋŋq ukŋlv_ŋ mmuqZv LpB ,iažcYŋ mmuqZvi `ŋU tŋŋŋ-gvbmmK mmuqZv I `ŋnK mmuqZv | gvbmmK mmuqZv A_ŋ ukŋŋYxq weltaqi ukŋlv_ŋ wPsb cŋŋŋ Dŋ'x Kiv | Ggb mgm'v, cŋŋev KvR t' l qv hvi mgvavb wPsb Kŋi tei KiŋZ nq | `ŋnK mmuqZv nŋj v nŋZ-Kj ŋg KvR Kŋi tkLv | ukŋlv jvf cŋŋŋq ukŋlv_ŋK mmuq ivLv tŋŋŋ Kg mgŋ I mnŋR ukLb mē |

7.1.2 gvb | GK aiŋbi KvŋR `xNŋngŋgŋt gŋbŋhvM w ŋZ cvŋi bv | wkiŋŋ i tŋŋŋŋ gŋbŋhvM t' l qvi e'wŋb eq'ŋ i tŋŋŋ Kg | wewfbaŋŋel Yvq t' Lv tŋŋŋ, 12 t_ŋK 16 eQi eqmŋ wkiŋŋ i tŋŋŋŋ G e'wŋb 8 t_ŋK 10 wgbU, Zv I Avevi wbfŋ Kŋi KvRw KZUv AvKŋŋq Ges Avb'`vqK | AZGe tkāY Kvŋŋŋ nŋte `ewPŋ'cYŋ Avŋj vPbv, `j MZ KvR, Mŋ, tŋ Lv, AuKv, wZK' Awfbq, nŋZ-Kj ŋg KvR, cŋŋēi, cŋŋB BZ'w' cvŋvi mŋ' mŋwZ tiŋL cŋŋŋM Kiv nŋj ukŋlv_ŋ gŋbŋhvM aŋi ivLv mē |

7.1.3 cŋŋ'K e'wŋB `Zšj (every individual is a unique) | ukŋlv_ŋ i tŋŋŋŋ Zv teŋk wetaPbvi `wē ivŋL | cŋŋ'K ukŋlv_ŋZvi wŋŋŋi gŋZv Kŋi wR MŋwZŋ tkŋL | ZvB e'wŋB `ŋZŋŋj K_v wetaPbvq tiŋL h_vmē ukŋlv_ŋ DcŋhvM Dcŋŋ mnŋhvMZV t' l qv nŋj ukŋlv_ŋ cŋŋŋ ukŋlvj vf mnR nq |

7.1.4 ukŋŋŋK ej v nq ŋēK cŋŋŋŋ | etŋi Dci eK `vcb Kŋi wēivU BgviZ `Zwi Kiv nq | GKBfŋte Rvbv AwfAZv, Ávb, `ŋŋZvi Dci wŋŋē Kŋi bZb Ávb, `ŋŋZv I gŋ'ŋeva ARB mnŋR mnvqZv t' l qv hvq | ZvB ukŋlv_ŋ Rieb t_ŋK Dcgv,

D`vniY w ŋŋ Ges ceŋä Ávb, `ŋŋZvi mŋ' mŋhvM `vcb Kŋi bZb Ávb, `ŋŋZv ARB mnvqZv Kiv nŋj ukŋlv jvf mnR nq |

7.1.5 ukŋlv_ŋ hv ukLte Zv eŋS ukLte | tKvŋbv wēl q mēúŋK'ŋŋ'úo aviYv jvf Kite | bv eŋS gŋ' Kiv h_v' ukŋlv bq | GŋZ ukLŋbi māvj b nq bv | eŋS ukLŋj ev tKvŋbv mgm'v mgvavŋi hv' I c×wZ eŋS cŋŋŋM Kiŋj Abjfc mgm'vi mgvavb wŋŋRB KiŋZ cvŋi | ZvB gŋŋ' i tŋŋŋ eŋvi Dci ,iažŋ' l qv cŋŋŋRb |

7.1.6 ukŋlv jvf h_vh_ ukŋŋŋvcKiŋYi mWVK e'envi AZ'sl ,iažcYŋ me weltaqi Kg-teŋk ukŋŋŋvcKiY e'envŋi mŋhvM Avŋŋ | ukŋŋŋvcKiŋYi mnvŋŋ' RuUj I wēgZ' wēl qŋK mnR I gZ'Kŋi Dc'vcb Kŋi wēl qŋŋŋK `úo aviYv t' l qv hvq | GKwU tQvU MvO tkāŋŋZ cŋŋŋ Kŋi Mŋŋŋi wewfbaŋŋ Ask ev gwēŋŋŋwŋq mŋŋŋŋŋ t' Lvŋj hZ mnŋR mWVK aviYv jvf mē Ab' tKvŋbvŋte Zv mē bq | gwēŋŋŋwŋq e'envŋi mŋhvM bv `vKŋj P`ŋ, cŋŋ' ex I mŋŋŋ Awfbq ev PvU' e'envi Kiv hvq |

7.1.7 ukLbŋK `vqxKiŋYi Rb' cŋŋŋRb Abjŋŋ ŋbi e'e'v | bZbŋte Avŋŋ Ávb, `ŋŋZv e'vi e'vi Abjŋŋ b Kiv nŋj GKw' ŋK thgb ukLb `vqx nq, Ab'w' ŋK ukLb māvj ŋbi mŋhvM mŋŋ nq |

7.1.8 ukŋlv ARB i tŋŋŋŋ ukŋlv_ŋ cŋŋ ukŋŋŋKi mnvŋŋŋZcY' AvPiY LpB ,iažcYŋ ukŋŋK-ukŋlv_ŋ mēúK'Ggb nŋte thb ukŋlv_ŋ' i ayŋj Lvcov wēl qK mgm'v bq, Zvi th tKvŋbv e'wŋMZ, cwēŋwi K mgm'v wēbv mŋŋŋŋŋ ukŋŋŋKi mŋ' Avŋj vPbv Kŋi | ukŋŋK mgm'v mgvavŋb cŋŋŋŋŋ' ŋeb Ges mŋ'gZ mnvqZv Kiteb | ukŋŋK-ukŋlv_ŋ gŋŋS tKvŋbv t' qv `vKŋte bv | mēúK'ŋte tŋŋŋ-k'vi Ges LpB Nŋbŋ I Avŋŋi K |

7.1.9 ukŋŋŋKi wēkŋŋ `vKŋZ nŋte th, Zvi mKj ukŋlv_ŋŋ tkLvi wŋŋ' mēúŋŋ' mēvi tkLvi Dcŋŋ I MŋwZi gŋŋ' cv_ŋ' `vKŋZ cvŋi, Zŋte Dchjŋ' cwēŋŋek I mnŋhvMZV tŋŋŋ mēvB tkŋL | tKvŋ ukŋlv_ŋ cŋŋ ukŋŋŋKi tŋwZevPK gŋbŋŋe `vKŋŋ H ukŋŋK t_ŋK ukŋlv_ŋ DcKZ nŋl qvi mēŋŋbv LpB Kg | ZvB cŋŋŋŋ ukŋlv_ŋ cŋŋ ukŋŋŋKi D'P aviYv `vKv evÁbŋq | tKvŋ ukŋlv_ŋK KLbŋ ŋŋv_vq tŋŋēi, ŋŋZvŋK w ŋŋ wKŋŋ nŋte bvŋ, ŋŋwŋŋ, ŋŋAc'v_ŋ' BZ'w' tKvŋbv aiŋŋi tŋwZevPK ev wbiŋŋŋŋŋŋ K K_v ej v hŋte bv | teZ e'envi ev tKvŋbv cŋŋvi kvŋŋŋ K ev gvbmmK kw' l cŋŋŋ ukŋŋv jvfŋi Ašŋŋŋ Ges ivŋŋŋ Avŋŋŋ kw'ŋŋŋŋ' Aciva | Drmnv cŋŋŋ Kiv nŋj ukŋlv_ŋ tkLvi Avŋŋŋ AŋbKŋUv teŋo hvq |

- **mn̄thwMzvgj K (Collaborative)** : MVber`x tkiY Kvh̄p̄g n̄te mn̄thwMzvgj K | w̄k̄v̄l̄v̄x̄p̄v̄ `tj i c̄ōZ`tki t̄t̄k c̄ōZ`tk w̄k̄l̄te Ges Ḡt̄K Ab̄t̄K w̄k̄l̄t̄Z mn̄thwMzV Kīte | h̄Lb w̄k̄v̄l̄v̄x̄p̄v̄ mḡteZf̄ite w̄k̄Lb c̄ōp̄qv̄ ch̄p̄j̄v̄Pbv̄ I Ab̄p̄v̄b̄ K̄ti ZLb Ziv̄ Ḡt̄K Ab̄t̄t̄K dj̄ c̄ōw̄ M̄b̄Y Kivi m̄j̄h̄M̄ c̄v̄q |
- **Ab̄m̄Ūvb̄ ev̄ m̄gm̄w̄f̄iĒK (Inquiry or Problem-Based)**: MVberf`i ḡj̄ K_v n̄t`Q m̄gm̄vi m̄ḡv̄ab̄ | G t̄p̄t̄t̄i w̄k̄v̄l̄v̄x̄p̄v̄ Ab̄m̄Ūvb̄ḡj̄ K c̄x̄w̄Zi ḡv̄a`tḡ c̄k̄eK̄ti, t̄K̄v̄t̄bv̄ w̄k̄Qj̄ m̄Ūvb̄ K̄ti Ges m̄ḡv̄ab̄ ev̄ DĒi c̄v̄l̄ q̄vi Rb̄ w̄ēf̄b̄ēc̄x̄w̄Z I t̄K̄S̄kj̄ c̄ōq̄M̄ K̄ti |
- **w̄eK̄v̄k̄ḡvb̄ (Evolving)**: w̄k̄v̄l̄v̄x̄p̄v̄ Zv̄t̄i ch̄p̄j̄v̄Pbv̄ I Ab̄p̄v̄t̄bi ḡv̄a`tḡ c̄t̄e^o Āw̄R̄Z t̄K̄v̄t̄bv̄ Áv̄b̄t̄K̄ Ām̄Z` I Ām̄ēv̄ȳ^o ḡt̄b̄ Kīt̄Z c̄v̄t̄i | t̄m̄t̄p̄t̄t̄i Ziv̄ Ab̄m̄Ūvb̄t̄bi ḡv̄a`tḡ b̄Zb̄ w̄m̄x̄v̄t̄s̄l̄ t̄c̄ōv̄t̄e | c̄ōP̄ōv̄ Pw̄j̄t̄q̄ h̄v̄te Ges b̄Zb̄ Áv̄b̄ I Āw̄f̄ÁZw̄f̄w̄Ēt̄Z c̄ēp̄ä w̄m̄x̄v̄s̄l̄ c̄p̄m̄s̄`v̄i Kīte |

8.3 MVberf`i m̄v̄t̄_m̄ḡM̄Zvev̄t̄i (Gestalt Theory) t̄ek̄ w̄ḡj̄ Āv̄t̄Q | Gestalt R̄v̄ḡp̄ō k̄ā h̄vi A_`Structure ev̄ M̄Vb̄ | w̄k̄Lb c̄ōp̄qv̄q̄ āviYv̄ M̄Vb̄ c_`K c_`K Dc̄v̄`v̄t̄bi Dci b̄q, m̄v̄ḡM̄K̄f̄v̄t̄e Dc̄v̄`v̄b_`t̄j̄vi Dci w̄b̄f̄P̄ K̄ti | MVberf`i I ḡj̄ K_v āviYv̄ M̄Vb̄ h̄v̄ w̄b̄f̄P̄ K̄ti w̄k̄ȳv̄x̄p̄ c̄ēp̄ä āviYv̄, Áv̄b̄, Āw̄f̄ÁZv̄ I c̄w̄i c̄w̄k̄R̄ Ae`vi Dci | m̄ḡM̄Zvev̄` Ab̄h̄v̄q̄x̄ t̄P̄v̄L, K̄vb̄, Z̄K̄ B̄Z`w̄ B̄w̄`t̄j̄v̄ ōv̄iv̄ Āvḡiv̄ th̄ Z_`t̄j̄v̄ c̄v̄B̄ t̄m_`t̄j̄v̄t̄K̄ Āvḡiv̄ ḡt̄b̄ ḡt̄b̄ c̄Ȳp̄z̄ īc̄ t̄`B, Āvi MVberf`i ḡt̄Z Āvḡiv̄ Ḡme B̄w̄`t̄j̄v̄ Z_`t̄j̄v̄ w̄t̄q̄ c̄ōZ`K̄ `Z̄s̄j̄ ḠK̄w̄ ḡv̄b̄w̄m̄K̄ w̄P̄Ī `Z̄wi i ḡv̄a`tḡ Āw̄f̄ÁZv̄ AR̄B̄ K̄wi | Ḡf̄v̄t̄e Āw̄R̄Z Āw̄f̄ÁZv̄ ḠK̄w̄i Dci ḠK̄w̄ m̄w̄R̄t̄q̄ w̄k̄Lb m̄ēv̄b̄ēK̄wi |

9. **w̄k̄Lb-t̄k̄L̄v̄t̄bv̄ K̄vh̄p̄ḡ c̄w̄i P̄vj̄ b̄vi K̄w̄Zc̄q̄ c̄x̄w̄Z I t̄K̄S̄kj̄**
 w̄k̄v̄l̄v̄x̄p̄v̄ w̄k̄Lb Āt̄b̄K̄v̄s̄t̄k̄ w̄b̄f̄P̄ K̄ti w̄k̄v̄l̄v̄x̄p̄v̄ K̄Z̄R̄ c̄w̄i P̄w̄j̄ Z c̄x̄w̄Z I t̄K̄S̄kj̄ i Dci | w̄k̄v̄l̄v̄x̄p̄v̄ i ̄q̄ḡZv̄ I c̄ēȲZv̄ Ges c̄v̄t̄Vi `enk̄t̄ō`i w̄f̄w̄Ēt̄Z c̄x̄w̄Z I t̄K̄S̄kj̄ w̄b̄ēP̄b̄ K̄iv̄ c̄ōq̄R̄b̄ | c̄x̄w̄Z I t̄K̄S̄kj̄ m̄w̄K̄ n̄t̄j̄ Ges h̄v̄h_`f̄v̄t̄e c̄ōq̄M̄ K̄iv̄ n̄t̄j̄ w̄k̄v̄l̄v̄x̄p̄v̄ m̄n̄t̄R̄ w̄k̄L̄t̄Z c̄v̄t̄i | ḠL̄v̄t̄b̄ K̄t̄q̄K̄w̄ c̄x̄w̄Z I t̄K̄S̄kj̄ i m̄s̄w̄q̄t̄b̄ c̄w̄i P̄q̄ t̄`l̄ q̄v̄ n̄t̄j̄ v̄:

9.1 **c̄k̄eDĒi c̄x̄w̄Z (Question-Answer Method)**
 c̄k̄eDĒi ḠK̄w̄ ēuj̄ c̄ōj̄ Z I K̄vh̄R̄i c̄x̄w̄Z | G c̄x̄w̄Zi m̄w̄K̄ c̄ōq̄v̄t̄Mi ḡv̄a`tḡ w̄k̄v̄l̄v̄x̄p̄v̄ m̄w̄q̄ t̄īt̄L w̄k̄L̄t̄b̄ mn̄thwMzV̄ K̄iv̄ h̄v̄q̄ | w̄ēf̄b̄ēD̄t̄īt̄k̄` c̄k̄eK̄iv̄ n̄t̄q̄ `v̄t̄K̄ | t̄k̄L̄vi R̄b̄` c̄k̄ē w̄k̄L̄b̄dj̄ AR̄B̄ c̄w̄i ḡt̄ci R̄b̄` c̄k̄ē t̄K̄vb̄ w̄ēt̄kl̄ K̄t̄ḡP̄ Dc̄t̄h̄wMzV̄ h̄v̄P̄v̄B̄ K̄ivi R̄b̄` c̄k̄ēB̄Z`w̄` t̄ek̄ K̄t̄q̄K̄w̄ āib̄ īt̄q̄t̄Q |

- 9.2 **c̄k̄eK̄ivi īw̄Z**
- m̄ḡ`l̄t̄k̄īt̄k̄ D̄t̄īk̄` K̄ti c̄k̄eK̄iv̄ | c̄ōt̄ḡ t̄K̄v̄t̄bv̄ w̄k̄v̄l̄v̄x̄p̄v̄ w̄b̄w̄`ō K̄ti Zv̄t̄K̄ c̄k̄eK̄iv̄ n̄t̄j̄ t̄k̄īYi Ab̄` w̄k̄v̄l̄v̄x̄p̄v̄ w̄b̄w̄`ēj̄ `v̄t̄K̄, Āḡt̄b̄v̄t̄h̄w̄M̄x̄ n̄t̄Z c̄v̄t̄i | m̄ev̄B̄t̄K̄ m̄w̄q̄ īv̄L̄vi R̄b̄` m̄ḡ`l̄t̄k̄īt̄k̄ c̄k̄eK̄īt̄Z n̄q̄ |
 - w̄P̄S̄ī K̄ti DĒi w̄K̄ K̄ivi R̄b̄` w̄k̄Q̄j̄v̄ m̄ḡq̄ t̄`l̄ q̄v̄ |
 - DĒi `v̄t̄b̄ k̄z̄L̄j̄v̄ ēR̄v̄q̄ īv̄L̄vi c̄v̄iM̄ w̄k̄v̄l̄v̄x̄p̄v̄ n̄v̄Z D̄V̄t̄e | m̄ev̄i ḠK̄m̄v̄t̄` DĒi t̄`l̄ q̄vi Āf̄`v̄m̄ Z̄v̄M̄ K̄iv̄t̄Z n̄t̄e |
 - w̄k̄v̄l̄v̄x̄p̄v̄ w̄b̄w̄`ō K̄ti DĒi w̄t̄Z ēj̄v̄ | ḠK̄B̄ w̄k̄v̄l̄v̄x̄p̄v̄ ēvi ēvi DĒi t̄`l̄ q̄vi m̄j̄h̄M̄ b̄v̄ w̄t̄q̄ ch̄p̄q̄m̄t̄ḡ m̄ev̄B̄t̄K̄ m̄j̄h̄M̄ t̄`l̄ q̄v̄ | c̄ōq̄v̄R̄t̄b̄ DĒi `v̄t̄b̄ B̄w̄z̄ w̄t̄q̄ m̄n̄v̄q̄Zv̄ K̄iv̄ | DĒi m̄w̄K̄ b̄v̄ n̄t̄j̄ Ab̄` w̄k̄v̄l̄v̄x̄p̄v̄ DĒi w̄t̄Z ēj̄v̄ |
 - m̄w̄K̄ DĒi c̄p̄iv̄ēj̄ē K̄iv̄ |
 - Ḡici c̄t̄e^on̄v̄Z D̄V̄v̄q̄ w̄b̄ Ḡgb̄ Āc̄v̄iM̄ w̄k̄v̄l̄v̄x̄p̄v̄ ḠK̄B̄ c̄ōk̄ē DĒi w̄t̄Z ēj̄v̄ |
 - c̄ōq̄v̄R̄t̄b̄ Ab̄m̄Ūvb̄x̄ c̄k̄ē(probing question) K̄iv̄ | ḠK̄w̄ c̄ōk̄ē DĒi t̄t̄k̄ th̄ c̄k̄ēR̄v̄t̄M̄ Zv̄t̄K̄ Ab̄m̄Ūvb̄x̄ c̄k̄ēj̄v̄ n̄q̄ |

9.3 **c̄ōk̄ē āib̄**

- c̄ōk̄ē f̄v̄l̄v̄ n̄t̄e m̄n̄R̄ I t̄k̄īY Dc̄t̄h̄w̄M̄x̄ |
- c̄ōk̄ēnt̄e w̄k̄v̄l̄v̄x̄p̄v̄ w̄P̄S̄ī D̄īx̄c̄K̄ I t̄c̄ōYv̄ m̄j̄ōK̄iv̄x̄ | ōt̄K̄b̄ō, ōw̄K̄f̄v̄t̄eō, ōK̄viȲ K̄w̄, ōēv̄L̄v̄ K̄iō, ōēt̄k̄īȲ K̄iō, ōZ̄j̄ b̄v̄ K̄iō B̄Z`w̄` ōv̄iv̄ c̄k̄ēK̄iv̄ n̄t̄j̄ w̄P̄S̄ī K̄ti DĒi t̄ēi Kīt̄Z n̄q̄ |

- thme c0k0e DEi 0ni0 ev 0b0 Ggb c0k0ev KivB fij | 0suz wbfP c0k0ehgb 0K0, 0tK0, 0tKv_0q0, 0K0u0 ev 0KvK etj 0 BZw c0k0hZUv m0e cwi nvi Kiv|
- ch0q0t0 Ggbfite c0k0eKiv thb c0k0g0ni DEi t_0tK velqe 0 m0u0tK0 u0 avi Yv jvf Kiv hvq | c0qvR0b c0k0e0i gvtS gvtS Avtj vPbv Kiv|
- Abm0vbgj K c0k0e(probing question) A_0f GK0W c0k0e DEi t_0tK D00Z c0k0e K0i vel0qi cY0v Avbv c0qvRb | thgb-
gj c0k0e 0vj t0 k0y0_0f i Mo Dcw0W KZ?
DEi : m0avi Y mg0q 85%, wetkl mg0q 50%
Abm0vbgj K c0k0e wetkl mg0q Kg tKb?
DEi : avb tivcY I avb Kv0vi tg0m0g t0tj tg0t0i A0t0K Kiv Kv0R Avf0veK0tK mrvqZv K0i ZvB Zviv 0vj t0 Av0m bv|

9.4 **wk0t0Ki KiY0q**

- m0wK DE0i Rb 0 wk0v_0fK Drm0v c0vb
- fij DE0i Rb 0 w0t0 Rbv I wkL0Z Ab0c0Yv t0 I qv
- m0wK DE0i c0h0 t0t0 Avtj vPbv gva0tg avi Yv jvf mrvqZv Kiv
- wk0v_0fK c0k0eK0iZ m0h0M t0 I qv, Drm0vZ Kiv Ges wk0v_0f c0k0e DEi t0 I qv

10. **0j MZ m0th0MZvgj K wk0v c0x0Z**

0j MZ m0th0MZvgj K c0x0Z GK0W mdj wkLbc0x0Z | G c0x0Z0Z GKB eqt0t0gi ev GKB ch0q0i wk0v_0f v ci 0ui w0_w_0fvi gva0tg wk0v jvf K0i | G0t0t0t wk0t0Ki f0gKv c0iv0f wK0 0iaZcY0 0j MZ Kv0Ri gva0tg c0Z0W wk0v_0f 0ay 0vb-0f ZvB 0j0 c0q bv, m0t_ m0t_ tek wK0y gvb0eK 0Yev0j i weKiv N0U | K_v tkvbvi I K_v ejvi k;Ljv Abj0Y, cigZ m0v0Zv, t0ZZ, mg0tSvZv BZw 0Yev0j i weKiv N0U |

10.1 **0j MVb**

w0f0b0fite 0j MVb Kiv hvq | mg-mvg0t_0f wk0v_0f i 0j, w0k0 mvg0t_0f wk0v_0f i 0j, velq0w0EK 0j, AAj w0f0EK 0j BZw | A0t0K t0t0t w0k0 mvg0t_0f i m0eav Ab0t0i t0t0t wK0y0v tek | c0Z c0t0vi Rb 0 ev c0Z vel0qi Rb 0 bZb K0i 0j MVb K0iZ t0t0t A0t0K mg0 jv0M | ZvB tk0w0k0fK

(w0w0 c0g w0w0q0W K0m t0b) 0j MVb K0i0eb | c0qvR0b GK g0m A0f0i A0f0i bZb K0i 0j MVb K0i0eb | G0Z wk0v_0f i w0_w_0fvi cwi mi 0j0 c0q | GKB tk0Yi w0f0b0vel0qi wk0fKMY tk0w0k0fK KZ0 M0VZ 0j 0tj v0KB 0j MZ Kv0R w0t0q0w0RZ K0i0eb | c0Z0W 0tj i AvKvi 6Rb t_0tK 8Rb ntj fij, Z0e 10R0bi tek n0 qv ev 0b0q bq | c0Z0K 0tj i GK0W K0i bvg 0vK0tj m0eav nq | dj, dj, c0w0, b0x ev is Gi b0t0g 0tj i bvg ivLv hvq |

10.2 **0j MZ Kv0Ri Avmb w0b0vm**

0j MZ Kv0Ri Avmb w0b0vm Ggb n0e hv0Z 0tj i mKj wk0v_0f g0t0vg0L em0Z c0t0i | tk0w0k0f0i AvKvi eo ntj Ges ch0f0 Avmevec0 0vK0tj, c0Z 0j t0w0j t0w0t0j i Pricv0k0em0te | G0f0 Avmevec0 bv 0vK0tj c0Kv t0t0S0Z g0f0i t0w0j nt0 em0Z c0t0i | bZev c0g tet0Ai wk0v_0f v N0i w0Z0q tet0Ai g0t0vg0L em0e, G0f0te ZZ0q tet0Ai PZ0tet0Ai g0t0vg0L | G0t0t0t c0Z 0tj i wk0v_0f i0K ci ci 0t0tet0Ai em0Z n0e | wk0fK 0j MZ Kv0R 0j0t0q t0 I qvi m0t_ m0t_ B 0j0ex0f0te 0t0m 0j MZ Kv0R 0i0e K0iZ n0e | Avmevec0 U0vbU0vb K0i mg0 b0 Kiv hv0e bv |

10.3 **0j MZ Kv0R Kivi c0q0q**

- 0tj f0M n0 qvi Av0MB mg0teZ Kv0m wk0fK 0u0 K0i 0j MZ Kv0R 0j0t0q w0 t0eb |
- wk0fK 0tj i GKRb0K GK0W Kv0Ri Rb 0j 0bZv g0t0vb0q w0 t0eb | ch0q0t0g 0tj i c0Z0K0K 0j 0bZvi 0w0Z0i w0 t0eb |
- wk0v_0f v 0tj f0M nt0 em0te | 0tj i c0Z0t0K velq0W w0t0q wP0f0 K0i0e | Zvici Avtj vPbv 0i0e K0i0e | GKRb K_v ejvi mg0 Ab0iv gb w0 t0 i0t0e | K_v gvtS t0K K_v ej0e bv | Z0e Avtj vPbv Ah_v 0xN0ev c0h0 ew0f0Z ntj 0j 0bZv f0f0te w0q0f0 K0i0e |
- 0tj i c0Z0t0K Avtj vPbv AskM0Y K0i0e |
- Avtj vPbv gva0tg Z0E, Z0, h0f0 Dc0vcb I h0f0 L0Eb K0i0e |
- Kv0t0v K_v Ac00 ntj ev gb0c0Z bv ntj 0ah0ati 0i0t0Z n0e, c0t0 h0f0 w0 t0 L0Eb Kiv hv0e, i0M Kiv ev A0t0k0fb Av0iY Kiv hv0e bv |
- t0Rvi K0i Ab0t0i Dci w0t0Ri gZvgZ Pw0ct0q t0 I qvi t0P0v Kiv hv0e bv |

c0k0 c×wZtZ wkqiv_ē i AbjñUrmv ep× cvq| mntR mñVK aviYv jvf KitZ cvti | wkLb AtcñKZ `xN°vqx nq| c0k0 c×wZtZ jñ i vLtZ nte thb me wkqiv_ē úó t`LtZ cvq|

12. AbjñUrbgj K KvRi aib

AbjñUrbgj K KvR gjZ KgñKw`K c×wZ| wvDBi mñpuzv ZtEj wfvEtZ cwi Pwj Z G c×wZtZ wkýv_xfv GKkfvtē ev `jMZfvte wbtRt`i c0Povq wbggZwšK c×wZtZ wkýv jvf Kti _vtK| G c×wZtZ wkýv_x°tKvbtv welq ev NUbv ev mgm`vi KviY, djvdj , c0Zñpuzv BZ`w` D`ñvUv Kti | bv_cĪ chñj vPbv, cwi`k0, chñeñY, mññvKvi MñY bvbvfvte AbjñUrb KvR cwi Pwj bv Kiv hvq| | D`vniY-

- hpmgvtRi AvKvk ms`wzi c0Z c0Yzv ep×i KviY I djvdj
- wkí AĀtj evqy`ttYi KviY I djvdj
- Lv` Drcv`tb AwZgvtvq ivmvgñbK KxUvbkK`ē` e`envt`i c0Zñpuzv

12.1. AbjñUrbgj K c×wZtZ wkLb cñpuzv

c0Z`KñU AbjñUrb Rb` GKñU welq ev mgm`v wbePb KitZ nq| G c×wZtZ hveZxq Kvñpuzv c0vzbZ cñpuzv chñq cwi Pwj Z nq| chñq _tjv nt`Q-

- K. mgm`v/Dt`ik` wbañY
- L. cwi Kí bv cñqb
- M. Z` msMñ
- N. Z` wtkñY
- O. c0Zte`b cñqb

me`c0tq Kvñpuzv mgm`v wPwYz Kiv ev Dt`ik` wbañY KitZ nq| w0Zxq chñq mgM0Kvñpuzv Rb` cwi Kí bv cñqb KitZ nq| Dt`ik` ARñbi Rb` Kx Kx KitZ nte, tKvñU wkfvte, Kx w`tq, KLb KitZ nte-G meB cwi Kí bv _vtK| Z` msMñ AbjñUrbgj K KvRi GKñU _iaZcY`ñi | c0Bgwi ev tñtK0vni Drm ntZ Z` msMñ KitZ nte| PZy`chñq Z` wtkñY I djvdj cñqb KitZ nte| meñkl wkýv_x m=úY`AbjñUrbgj K KvRi Dci GKñU c0Zte`b cñqb Kite|

13. wkLb- tkLvbtv Kvñpuzv m=úY`KtqKñU K_v

wkLb-tkLvbtv c×wZ I tKškj AtbK aittbi | Gi KtqKñU wkñKtKw`K Ges KtqKñU wkñKtKw`K | wkLb-tkLvbtv cñpuzv wkñKtKw`K mñpuzv AskMñY wkñKtKw`K mñvqK| me c×wZiB Kgñewk mñeav I Amñeav AvtQ| Ggb tKvbtv c×wZ ev tKškj tbB thñU mKj wkñKtKw`K Rb` mgfvte DcñvMx ev me aittbi welqe`i Rb` DcñvMx| wkñKtKi wewfbac×wZ I tKšktj i Dci `ñZv Ges tkñY I cvV DcñvMx c×wZ I tKšktj i h_vh_ c0qvMi Dci wbfP Kti wkñKtKw`K wkLb mvdj` | Ggb tKvbtv eva`evaKZv tbB th GKñU cvV cwi Pwj bvq wkñKtKw`K GKñU c×wZi Dci wbfP KitZ nte| cvVtK dj cñ-Kivi Rb` wkñKtKw`K cwi w`wZ Abjñvñi GKwaK c×wZ I tKšktj i mñvqñY wbtRi gtZv Kti cvV cwi Pwj bv KitZ cvtib| cvVtK mvdj` wbfP Kti wkñKtKi wewfbac×wZ, welqAvb I wkLb c×wZi h_vh_ c0qvMi Dci | GRb` ejv nq wkñKtKw`K mñeav Kó c×wZ | wkñKtKw`K wkLb-tkLvbtv c×wZ eúwea| GLvbtv gvĪ KtqKñU wkñKtKw`K c×wZ mñññc Dc`vcb Kiv ntjv| Zte wkñKtKi AvñK msL`K c×wZ I tKšktj i Dci `ñZv _vKv c0qvRb| Zvntj wZvb th tññt th c×wZ DcñvMx Zv c0qvM KitZ cvtib| c0qvRtb GKwaK c×wZi mñvqñY wbtRi gtZv Kti cvV cwi Pwj bv KitZ cvtib| cvV cwi Pwj bvi mgq wkñKtKw`K hñ` eñstZ cvtib th c0qvMKZ c×wZ wkýv_x` i wkLtb dj cñ-nt`Q bv ZLb wZvb c×wZ cwi eZ0 KitZ cvtib| ZvB wkñKt`i eú c×wZi Dci `ñZv _vKv Avek`K |

14. wkýv_x`gj`vqb

mñvaviY At`wkýv_x` gj`vqb ntjv wkýv Kvñpuzv t`tK wkýv_x` ARñbi gvĪv wbyñ Kiv| A`ñ wkýv_x` DññLZ ce`wbaññi Z wkLbdj wkýv_x`KZUv ARñ KtittQ Zv wbiñcYB wkýv_x` gj`vqb| hñ I gj`vqb K_wñU w`ñiz AtbK e`vcK| Avgiv wewfbamgtq bvbvfvte wkýv_x` gj`vqb Kti _wñK| gj`vqtb mgq I aib wetePbv wkýv_x` gj`vqb c0vzbZ `ß avivi : (K) MvBkvj xb ev avivewñK gj`vqb Ges (L) mvgw0K gj`vqb | Avgiv cvV Pj vKvj xb ev wñw`0 cvV`vsk t`tK wkýv_x` ARñ gj`vqb Kti _wñK | G gj`vqb avivewñK ev MvBkvj xb gj`vqb | Avevi Avgiv wñw`0 mgq tktl ev Kvñpuzv tktl mvgw0K cixyv, ewl`K cixyv, GmGmñm cixyv BZ`w` cixyvi gva`tg gj`vqb Kti _wñK | G aittbi gj`vqb nj

mvgwóK gj`vqb | avivevNK I mvgwóK DfQ avivi gj`vq̄tbi B c̄q̄Rb AvtQ | Zte avivevNK gj`vq̄tbi i aZ; AþK teik | KviY-

- avivevNK gj`vq̄tbi gva`tg wkyv_ŕi wPwYZ wLb `p̄Zv ZvrýwYK wbt`Rbv c̄q̄tbi Øviv wbi vgggj K e`e`v tbi qv hvq |
- wkyv_ŕi nvtZ-Kj tg e`enmi K KvR Kivi c̄q̄qv chfeytYi gva`tg gj`vqb Kti wbt`Rbv t`l qv hvq |
- wkyv_ŕi wtkl wQz `yZv, thgb- tkvbn, ejv, cov BZ`w` Kg mgta, Kg LiþP I mntR cwi gyc Kti avtc avtc wbt`Rbv t`l qv I wbi vgggj K e`e`v tbi qv hvq | mvgwóK gj`vq̄tbi gva`tg AþK týtĭ Gme `enkto`i gj`vqb Kiv mæe nq bv |
- wkyv_ŕi AvteMxq w`Kmgñ wtkl Kti e`w`K I mvgwRK AvPiY Ges gj`teva cĭ`y chfeytYi gva`tg gj`vqb Kti wbt`Rbv t`l qv hvq |
- G gj`vq̄tbi gva`tg wkyK Zwi e`eüZ wLb tkLvtbv c`xwZ I tKšktj i h_v_Zv I dj cñZv wbaŕiY Kti ev `p̄Zv wPwYZ Kti c̄q̄Rbxq cwi eZB AvbtZ cvtib |

15. avivevNK gj`vqb

avivevNK gj`vq̄tbi gva`tg wkyv_ŕi `p̄Zv wPwYZ Kti wbt`Rbv t`l qv hvq Ges c̄q̄Rtb wbi vgggj K e`e`v MñY Kiv hvq |

ersjvt`tk 6ó t`tK 10g tkñY chšI wbaŕi wLZ `Bw týtĭ avivevNK gj`vqb Kvhpug Pj te |

1. wel qwŕwĖK ep̄xeĖxq I gtbvtcwkR týtĭi avivevNK gj`vqb
2. AvteMxq týtĭi avivevNK gj`vqb

15.1. wel qwŕwĖK ep̄xeĖxq I gtbvtcwkR týtĭi avivevNK gj`vqb

- wclkwyK wclkwŕwĖK ep̄xeĖxq I gtbvtcwkR týtĭi avivevNK gj`vqb Kiteb
- cĭZw wcltq avivevNK gj`vq̄tbi Rb` eivĭ KZ baf 20%

cĭZw wcltq avivevNK gj`vq̄tbi týtĭ I baf eĖB :

týtĭ	baf
K. tkñYi KvR	10
L. emoi KvR I AbmÜvbgj K KvR	05
M. tkñY Afxyv	05
tgwU	20

cĭZ wclq wkyK KZR `^`^ wcltq cĭZ wkyv_ŕiK 20% baf i wŕwĖtZ avivevNK gj`vqb Kti wbaŕi Z Qtk gj`vqb ti KWŕmsi`yY Kiv nte |

15.1.1. tkñYi KvR

- wLb-tkLvtbv Kvhpug Pj vKvj xb wkyv_ŕiKZR mæwñ Z hveZxq KvR tkñYi KvR wmwte wetePZ | wclqft` tkñYi KvRi aiþb Zvi Zg`_vKtZ cvti | Awakusk týtĭB c̄kæ DEi ejv ev tj Lv, AwKv (wPĭ/Ow, mviwY, gvbwPĭ, tj LwPĭ), Avtj vPbv I weZtK`AskMñY, Pwiĭ-Awfbq, e`enmi K KvR-G aiþbi me wKOB tkñYi KvR | ersjv I BstiwR wcltq tkvbn, ejv, cov, tj Lv BZ`w` tkñYi KvR wmwte wetePZ nte |
- cĭZw wcltqi Rb` cĭZ mvgwóK wZbw tkñYi KvRi gj`vqb ti KWŕmsi`yY Kiv nte | thme wcltq e`enmi K KvR AvtQ (weÁvb, c`v weÁvb, imvqb, RweÁvb, Kw wkyv, Mm`weÁvb, kvixi K wkyv I `v`, Kg`I Rwebglx wkyv BZ`w`) Hme wcltq GKw e`enmi K KvR I `wU tkñYi KvRi ti KWŕwLv nte |
- wclkwyK KZR wbcqZfite cĭZ`K wkyv_ŕiK gj`vqb Kiv nte Ges cĭZ `B gŕm GKeri Kti cĭZ mvgwóK (Oq gŕm) 3evi gj`vqb ti KWŕmsi`yY Kiv nte |

15.1.4. tkW Afxyv

cWZw Aa'vq tkW tkW Afxyv tbi qv nte| Zte Awak baf cWb Afxysi baf tiKWivLv nte| tkW Afxysi DEicT wkyv_K t' Llevi ci tdiZ vbtq msiyY Kiv nte| thme wltq e'enwi K KvR AvtQ Hme wltq `WU e'enwi K I GKwU wj wLZ Afxysi tiKWmsiyY Kiv nte| Ab'vb' wltq wZbuU wj wLZ Afxysi tiKWivLv nte| e'enwi K KvRi gj'vqtb i gvb`E tkWtZ m'uw` Z e'enwi K KvRi Abjfc nte| tkW Afxyv wj wLZ ev e'enwi K nte| cWZw tkW Afxyv `f mgq tbi qv nte| wltqi Rb' wbaW Z Kw m'wci qW tbi qv nte| wbaW Z GK Kw m'wci qWi AwZwi 3 mgq tbi qv hte bv| tkW Afxysi w' b tkWi Ab'vb' wci qWi `fweK KvRKg`h_viz Pj te|

16. AvteMx tytli avivewNK gj'vqb

wkyvutg wkyv_xp e'w3K Dbqtb i Dci _iaZ; Avivc Kiv ntqtQ| GKRb wkyv_x i aytagavex ntj B nte bv ZvtK fvtjv gvb| I ntZ nte| fvtjv gvb| i _Yvej ARB KiZ nte| GKRb wkyv_x'fvtjv gvb| wKbv Zv RvbtZ ntj Zvi AvPiY I `wofwZ gj'vqb KiZ nte| avivewNK gj'vqtb i gva'tg wkyv_xp e'w3K AvPiY I mvgwRK gj'teva gj'vqb Kiv nte| w'vj tq wkyv_xp i AvPiY I mvgwRK gj'teva tKvfv GKwU NUbv ev Bmj w'tq ZrvyWYKfvte gj'vqb Kiv hvq bv| w'vj tq wkyv_x' tkWi KvRi cvkvcwk cWZwbqZ eu KgRvtE AskMAY Kite| G_tjv ntjv `wbK mgvtek, tLjvajv I μov, mvs`wZK Kvhpug, wkyv mdi I cwi`k, RvZxq w'em D`hcb, agrq Abpib, weAvb tgjv, MwZ Awj w'wqW, etqR `wDum, Mj hMBW, weGbwmm Ges cwi'tek msiyYi Kvhpug BZ'w | wkyv_xp i weifbKvRvtEi ga' w'tq `xN' ch'eyYi gva'tg Zv' i AvPiY I gj'teva m'w'fK GKwU wbfPthM' gj'vqtb Avmv hvq| wkyvutg AvteMx tytli wLbdj gj'vqtb i AvLzq Avbv ntqtQ| G tytli th _Yvej I gj'teva cwi gvtci AvLzq Avbv ntqtQ tm_tjv nj - wqgvbZzv, t'ktg, tbZZ; mZZv, k;Ljv, mntwMzv, m'wq AskMAY, m'wZv, m'PZbZv I mgqgvbZzv| tkWwkyv K Ab'vb' w'wkyv K m'w' c'wvK'Kti AvteMx tytli gj'vqb Kiteb I tiKWmsiyY Kiteb|

17. mvgwK cixyv I cvej K cixyv

RvZxq wkyvug 2012 Gi wbt' Rbv Abjvti w'vj tqi wkyvel© Oq gume'vcx `WU mvgwK fvm Kiv nte| cWZ Oq gvtm GK mvgwK wmvte cWZ wkyv eQti `WU mvgwK cixyv AbjvZ nte| cWZ mvgwK cixyv tkW avivewNK gj'vqtb cWb baf K GKwZ Kti `WU mvgwK cixyv cWb baf Ges avivewNK gj'vqtb cWb baf i mgstq cWZ wkyv_x cieZ'PZI tkW ev Kvhpug DbwZ Kivi w'q wetePbv Kiv nte|

mvgwK Ges cvej K cixysi ckeT c'vq Ges DEicT gj'vqb mRbkj cke_xiZi wbt' Rbv Abjvti msMwZ nte| wkyv etl' i i'atZ w'wkyv c'w' wkyv Kti m'w' c'wvK'Kti wkyvutg cW' E Aa'vqmgatK `WU mvgwK Kti Rb' eEb Kiteb| w'vj tqi Kvhpug etmi cwigvYi Dci w'fE Kti Aa'vqmgatK mvgwK eEb Kiteb nte| cW mvgwK gj'vqbKZ Aa'vqmgatK wZxq mvgwK gj'vqtb i Rb' e'envi Kiv hvte bv| Zte Aog I `kg tkWi cvej K cixysi (JSC, SSC) Rb' GB wbt' Rbv c'w' h'v' bq| w'wkyv tm Abjvti cW Kvhpug cwi Pjv bv Kiteb| mvgwK tkW **Abjvq cixyv wkyvutg w'q Ges c'f'i Rb' eiv'KZ cY'w' nte| wkyvug i'f'iLvi w'qKw'v'q w'ltqi cY'w' t' I qv AvtQ|**

mRbkj cke_xiZi ckeT `B a'f'i cke_vKte| GKwU nt'Q e'w'w' cke Ges AciuU nt'Q mRbkj cke e'w'w' ckeT wZb a'f'i e'w'w' cke _vKte| G_tjv nt'Q m'v'v' e'w'w' cke e'w'w' x mgw'w'PK e'w'w' cke Ges Avf'w'Z' w'f'w'K e'w'w' cke e'w'w' ckeT w'Psb `yZvi Pvi `f'i cke Avb'w'ZKv'v' _vKte| mKj Aa'vqK cixysi AvLzvf3 KiZ nte| ckeT c'vqtb i c'w'w' Rk Qk `Zvi KiZ nte| cWZw mRbkj cke GKwU D'ixcK _vKte Ges D'ixcK m'w' 4wU cke_vKte| cke4wU w'tq w'Psb `yZvi Pvi w'li (Avb, Av'w'eb, c'w'w' Ges D'PZI `yZv) hvPvB Kiv nte| baf c'w' wbt' w'Kv AbjvY Kti DEicT gj'vqb KiZ nte|

3. tUKubK`vj Kugul		
μugK	bvg I c`ve	KugulZ c`ve
1.	c0dmi tgrt Ave`j ReIvi c03b cwi Pvj K, bvtqg, XvKv (emv bs-7, moK bs-11, tm±i bs-4, DEiv gftWj UvDb, XvKv-1230)	AvnevgK
2.	Aa`vcK W. Aveynug` j wZd mꝑvi ubDgwi Aa`vcK, AvBBAvi, XvKv wekte`vj q, XvKv	m`m`
3.	c0dmi Ave`jn mꝑnvb c03b gnvcwi Pvj K, c0ugK uk`v Avā`Bi (m-8, emv bs-52, tiwW bs-6/G, avbgmU AvevmK Gj vKv, XvKv)	m`m`
4.	Aa`vcK W. tMjvg imj wgvv c03b Aa`v, wPm`v UibS Ktj R, XvKv (emv bs-47, tiwW bs-02, tm±i -09, DEiv gftWj UvDb, XvKv-1230)	m`m`
5.	W. tgrt wQvī Ki ingvb ci vgrK GmBGmMw, gva`ugK I D`Puk`v Avā`Bi, uk`v Feb, XvKv	m`m`
6.	c0dmi W. tgrt bvrGj Kwi g tPšajx e`e`vcv wefvM, XvKv wekte`vj q, XvKv	m`m`
7.	W. Avāj gvTj K Aa`vcK, AvBBAvi, XvKv wekte`vj q, XvKv	m`m`
8.	Rbve tgrv`š Rwkī tnrTmb uk`v μg wekI A GmBGmMw, GbimUve, XvKv	m`m`
9.	Rbve kvnxbiv telMg wekI A, GbimUve, XvKv	m`m`
10.	Rbve tgrt tgrLtj m Di ingvb wekI A, GbimUve, XvKv	m`m`
11.	Rbve tgrt di nv`j Bmjvg EaYzb wekI A, GbimUve, XvKv	m`m`-mPe

4. tfuls Kugul		
μugK	bvg I c`ve	KugulZ c`ve
1.	evsjv	1. Aa`vcK Ave`j m Aveymvq` cwi Pvj K, wekfmwZ` tK` ; XvKv 2. c0dmi bi Rvnb telMg Aa`v, mi Kwi weAvb Ktj R, XvKv
2.	BstivR	1. c0dmi Ave`jn mꝑnvb c03b gnvcwi Pvj K, c0ugK uk`v Avā`Bi, XvKv (m-8, emv bs-52, tiwW bs-6/G, avbgmU AvevmK Gj vKv, XvKv) 2. c0dmi tgrt kvgmj nK c03b Wvb, evsjv`k Dbv` wekte`vj q, MvRvcj (emv bs-25, G`vcUfgU-we-5, tiwW bs 68G, j kvb-2, XvKv-1212)
3.	MwYZ	1. c0dmi W. tgrt Avāj gwZb MwYZ wefvM, XvKv wekte`vj q, XvKv 2. c0dmi W. tgrt Avāj Ovgv` MwYZ wefvM, XvKv wekte`vj q, XvKv
4.	weAvb	1. c0dmi W. tgrt AwRRj ingvb c`v weAvb wefvM, XvKv wekte`vj q, XvKv 2. Rbve tgrv`š bfi Avj g wmi`Kx mnhMx Aa`vcK, AvBBAvi, XvKv wekte`vj q, XvKv
5.	evsjv`k I wekcvPq	1. c0dmi W. nviab Di iuk` i vóteAvb wefvM, XvKv wekte`vj q, XvKv 2. W. `mq` nwdRj ingvb mnhMx Aa`vcK, cwi tek weAvb wefvM Rvrvzi bMi wekte`vj q, mfvvi, XvKv
6.	Z` I thvMvthvM c0v3	1. c0dmi W. gnr`š Rvdi Bkevj KwúDUvi mvtqY GÜ BvAvbqwi s wefvM kvrvj vj weAvb I c0v3 wekte`vj q, wntj U 2. Rbve tgrt mvdDj Avj g Lvb mKvix Aa`vcK, Z` c0v3 BvUvUvDU, XvKv wekte`vj q, XvKv
7.	cwi tek cwi vPvZ	1. c0dmi W. G Gm Gg gvKmj Kvgj fZÉ; wefvM, XvKv wekte`vj q, XvKv 2. c0dmi W. tgrt Lexi Dlx cwi tek weAvb wefvM, Rvrvzi bMi wekte`vj q, mfvvi, XvKv

veI q : D'PZi MwZ		tkW : beg-`kg
μvgK	bvg I c`ve	KvgUłZ c`ve
1	W. tgvT Avāj gWZb cŃdmi, MwYZ wefvM XvKv wekte`ij q, XvKv	AvnevgK
2	W. tgvT AvBbj Bmj vg cŃdmi, MwYZ wefvM XvKv wekte`ij q, XvKv	m`m`
3	W. tgvT Avājn Qvqv` cŃdmi, MwYZ wefvM XvKv wekte`ij q, XvKv	m`m`
4	W. Agj Kō nvj`vi cŃdmi, MwYZ wefvM XvKv wekte`ij q, XvKv	m`m`
5	Rbve bi tgvnvš` cŃvI K, weqvg gŃWj`j GŃ Ktj R, XvKv	m`m`
6	Rbve tgvT bvmi Dvıl b weŃkI Á, GbıvıUve, XvKv	m`m`
7	Rbve bıRbıb AvLZvi Kvı Kj vg weŃkI Á, GmBGmıWıc, GbıvıUve, XvKv	mgšqKvıx

6. mweR mgšq KvgU		
μvgK	bvg I c`ve	KvgUłZ c`ve
1.	Rbve tgvnvš` RvıKi tıvımb Kvı Kj vg weŃkI Á I GmBGmıWıc tıvıKvj cŃqU Kvı Kj vg tWŃfj cŃqU BDıbU RıZıq vıyıμg I cW`cŃ K teWı, XvKv	mweR mgšqKvıx
2.	Rbve tgvıZvıK Avıtg` fıBqv weZıY vıbqšK RıZıq vıyıμg I cW`cŃ K teWı, XvKv	mweR mgšqKvıx

rikýning

MWZ

lô-Aóg tkö

2. Dđi k

1. MvYZ wkývq DrmvrX I AvMóx ntq thš³K Ges MVbgj K wPšiq D0x nI qv |
2. wefbcšvi msl'vi 'enkó" m=útK@avi Yv jvf Kti MwYwZK mgm'v MVb KitZ D0x ntq Zv mgravtb mýg nI qv |
3. HwKK, AbcvZ I kZKiv mšmšimgm'v mgravtb `ŋZv AR0 Kiv |
4. cwi gvc m=úwKZ Ávb I e'enwi K `ŋZv AR0 Kiv |
5. exRMwZiq mŋvej AvqE Kiv Ges mŋvej c0qvMi gra'tg mgm'vi mgravb KitZ cviv |
6. c'vUvb@I tj LwPŋ m=útK@avi Yv jvf Kti mgm'v mgravb KitZ cviv |
7. exRMwZiq mgxKiŋYi avi Yv jvf, mgxKiY MVb I mgravtb mýg nI qv |
8. R'wgvZK mgm'v mgravtbi wefbcšvi ntZ mte@KóuU wbePtb mg_ŋI qv |
9. MwYwZK Dm'3i mZ'Zv hvPvB Kivi `ýZv AR0 Kiv |
10. R'wgvZK wPŋ A¼tbi mvrth" wkýv I KgRxtb nıZ I tPvL e'envtii tKškj iB Kiv |
11. tmU I tmŋUi Kvheva tRtb MwYwZK mgm'v mgravb KitZ cviv |
12. Z_ -DcvŋEi c0qvKiY I tj LwPŋi mvrth" Dc'vcb Ges tK'ıq c0YZv wYŋq `ŋZv jvf Kiv |

3. cūšK ũkLbdj

eġeġxq

1. ṽfweK msL'v , gj` I Agj` msL'v , eMġj , c'vUrb⁹ tj LwPĪ eY⁹ KiŹ Ges wefbratĭbi c'vUrb⁹ LĭZ I GZ` ĩnsμvšĭ wefbrmgm'vi mgravb KiŹ cviŹe|
2. ṽbw`b RxeŹb AbjcvZ-mgvbpcvZ , HwKK ũbqg , kZKiv , jvf-ŹĭwZ I gpcv dv m=ūwKŹ mgm'vi mgravb KiŹ cviŹe|
3. cwi gŹci wefbræcxwZ eY⁹ Ges ṽbw`b RxeŹb Gi e'envi m=ūwKŹ mgm'vej i mgravb KiŹ cviŹe|
4. cY⁹msL'v I wPŹy⁹ msL'vi 'eukó' e'vL'v KŹi cŹqM KiŹ cviŹe|
5. exRMwYzXq i wK eY⁹ KiŹ cviŹe Ges cŹxK , Pj K , mnM , mPK , wPŹy⁹ msL'v BZ'w i gra'tg Zv cKvk KiŹ cviŹe|
6. exRMwYzXq i wK thvM , weŹqM , Ź Y I fvM KiŹ cviŹe Ges GZ` ĩnsμvšĭ mgm'vi mgravb KiŹ cviŹe|
7. exRMwYzŹi cŹg PriwU eŹM⁹ mŹ I NbdŹj i mŹ eY⁹ KiŹ cviŹe Ges G_Ź tjv cŹqM exRMwYzXq i wK gvb ũbY⁹ KiŹ cviŹe| |
8. exRMwYzXq i wK Drcv'ŹK weŹkŹ Y KiŹ cviŹe Ges M.mv. Ź I j.mv. Ź ũbY⁹ KiŹ cviŹe|
9. exRMwYzXq i wK fM⁹Źki avi Yv e'vL'v KŹi GŹ' i thvM , weŹqM , Ź Y I fvM KiŹ cviŹe Ges GZ` ĩnsμvšĭ mgm'vi mgravb KiŹ cviŹe|
10. mij mgrKiY I mij mnmgxKiY MVb Ges mgravb KiŹ cviŹe|
11. D`niY I cŹxŹKi mnvth` tmU e'vL'v KiŹ cviŹe Ges tmU cŹqM e'envŹi i gra'tg wefbrmgm'vi mgravb KiŹ cviŹe|
12. R'wgvZi tgšj K weŹq_Ź tjv e'vL'v KŹi mgm'v mgravb KiŹ cviŹe|
13. mgršĭj mij Źi Lv I ŹQ` K Źviv DrcbeŹKŹi 'eukó' eY⁹ I cŹqM KiŹ cviŹe|
14. wĭ fŹRi 'eukó' e'vL'v KiŹ cviŹe Ges wĭ fRmsμvšĭ tgšj K Dccv` cŹvY KŹi cŹqM KiŹ cviŹe|
15. meŹgZv I m`kZvi 'eukó' e'vL'v KŹi tgšj K Dccv` cŹvY Ges mgm'v mgravb KiŹ cviŹe|
16. PZfŹRi ag⁹ej e'vL'v KiŹ cviŹe Ges MmYwZK Dv⁹i mZ'Zv hvPvB , cŹvY I cŹqM KiŹ cviŹe|
17. cvB(π)Gi avi Yv e'vL'v KŹi eŹĪi ŹyĪdj I cwi mxgv ũbY⁹ KiŹ cviŹe|
18. eĪ mspvšĭ tgšj K Dccv` cŹvY KiŹ cviŹe Ges GZ` ĩnsμvšĭ mgm'v mgravb KiŹ cviŹe|
19. Z_Ź I DcvĪ nŹZ Mo , ga`K , cŹi K ũbY⁹ KŹi G m=ūwKŹ mgm'v mgravb KiŹ cviŹe|

Avtəlliq

1. msL`v vb`q tLj vi gva`tg wvfbomsL`wfvE`K tLj v `Zwi tZ m`Pó nte |
2. `b` b Rxe`bi mnR MwYwZK wnmve vbKv`k HwKK vbqg, kZKiv I AbcvtZi c`qvRbxqZv Dcj w` Kti wnmve Ki tZ Drmvrn nte |
3. exRMwYtZi mvt_ cwi wPZ n`q exRMwYZxq mgm`v mgvavtb AvM`bx nte |
4. exRMwYZxq mgxKiY MVb Kti mnR mgm`v mgvavtb AvM`bx nte |
5. tm`Ui mvrvt`h` Z_`tK b` vbKfvte Dc`vc`tb m`Pó nte |
6. MwYwZK mgm`v mgvavtb th`w`K wP`S`q D`y` nte |

g`bv`c`kR

1. h_vh_fvte OK KvMR e`envi Kti tj LwP`A`v Ki tZ cvi te |
2. mij mgxKiY I mij mn mgxKi tYi mgvavb tj LwP`t` t` Lv tZ cvi te |
3. tj LwP`t`i mvrvt`h` mij mnmgxKi tYi mgvavb Ki tZ cvi te |
4. `b` b Rxe`tb wvfboc`wZ`Z cwi gvc Abgvb Ki tZ cvi te |
5. h_vh_ (appropriate) cwi gvcK e`envi Kti AvqZvKvi Nbe` ; NbK, tKvYK, tej b I e`EvKwZ e`i t`y`dj cwi gvc Ki tZ cvi te |
6. c`E Z`_i wfvE`tZ DcKiY e`envi Kti R`wgvZK wP`A`v Ki tZ cvi te |
7. Z`_DcvE`tK tj LwP`t` cKvk Ki tZ cvi te |

4. cōšK ũkLbdŧj i tkōwfwĒK wfvRb

lō tkōw	cōg Aa'vq	mšg tkōw	cōg Aa'vq	Aóg tkōw	cōg Aa'vq	cōšK ũkLbdj
<p>cĹ'vkv Kiv hvq th, Aa'vq tkŧl ũkŷv_xfv- eŷ×eĒxq</p> <ol style="list-style-type: none"> 1. ʹfwēK msL'vi A¼cvZb KiŧZ cviŧe 2. †kxq I AvšRwZK iŵiZŧZ A¼cvZb Kŧi coŧZ cviŧe 3. wfvR'Zv e'vL'v KiŧZ cviŧe 4. 2, 3, 4, 5, 9 ōviv wfvR'Zv hvPvB KiŧZ cviŧe 5. mvariY fMusk I ʹkugK fMuskŧi M.mv. ʹ I j.mv. ʹ wbyŋ KiŧZ cviŧe 6. mvariY fMusk I ʹkugK fMuskŧi mijxKiY Kŧi MwYwZK mgm'vi mgvavb KiŧZ cviŧe <p>AvŧelMxq</p> <ol style="list-style-type: none"> 7. msL'v mæúŋK †KšZnjx ntq wfvbæ aiŧbi msL'wfwĒK gRvi gRvi tLjvq Drmvrnx nŧe 	<p>cĹ'vkv Kiv hvq th, Aa'vq tkŧl ũkŷv_xfv- eŷ×eĒxq</p> <ol style="list-style-type: none"> 1. gj` I Agj` msL'v kbr³ KiŧZ cviŧe 2. msL'vŧiLvq gj` I Agj` msL'vi Ae'vb †LvŧZ cviŧe 3. msL'vi eMŋ eMŋj e'vL'v KiŧZ cviŧe 4. Drcv'K I fvm cōµqvŧi gva'tg eMŋj wbyŋ KiŧZ cviŧe 5. msL'vi eMŋj c×wZ ʹtjv cōqvM Kŧi ev'b Rxeŧbi mgm'vi mgvavb KiŧZ cviŧe 	<p>cĹ'vkv Kiv hvq th, Aa'vq tkŧl ũkŷv_xfv- eŷ×eĒxq</p> <ol style="list-style-type: none"> 1. c'vUvb'Kx Zv e'vL'v KiŧZ cviŧe 2. wfvbæ aiŧbi c'vUvb'wŋj LŧZ I eYŋv KiŧZ cviŧe 3. AvŧiwcZ kZŋhvqx mnR c'vUvb'wŋj LŧZ I eYŋv KiŧZ cviŧe 4. c'vUŧbP wbw'ŋZg msL'v ŧei KiŧZ cviŧe 5. c'vUvb'K PjŧKi gva'tg exRMwZxq i wkgvj vq cKvk KiŧZ cviŧe <p>AvŧelMxq</p> <ol style="list-style-type: none"> 6. msL'v wbtq tLjvi gva'tg msL'vi cōZ AvMŋx ntq DVŧe 7. wfvbæ msL'wfwĒK tLjv ʹZwiŧZ mŧPó nŧe 	<p>cĹ'vkv Kiv hvq th, ʹi tkŧl ũkŷv_xfv- eŷ×eĒxq</p> <ol style="list-style-type: none"> 1. ʹfwēK msL'v, gj` I Agj` msL'v, eMŋj, c'vUvb'ŋj tLjwPŧ eYŋv KiŧZ Ges wfvbæ aiŧbi c'vUvb' wŋj LŧZ I GZ' ŋspvšŧ wfvbæ mgm'vi mgvavb KiŧZ cviŧe <p>AvŧelMxq</p> <ol style="list-style-type: none"> 2. msL'v wbtq tLjvi gva'tg wfvbæ msL'wfwĒK tLjv ʹZwiŧZ mŧPó nŧe 			

I ô tkôv	mBg tkôv	ZZxq Aa`vq	Aóg tkôv	ZZxq Aa`vq	côšK wkLbdj
	<p data-bbox="653 272 1131 342">cZ`vkv Kiv hvq th, Aa`vq tk†l wkÿv_xfv- eÿ×eËxq</p> <ol data-bbox="653 347 1131 574" style="list-style-type: none"> <li data-bbox="653 347 1131 451">1. `N`cwi g†ci Avštm=úK`e`vL`v Ki†Z cvi †e Ges G msµvšlmgm`v mgravb Ki†Z cvi †e <li data-bbox="653 472 1131 574">2. IRb I Zij c`vt_Ŧ AvqZb cwi gvc wkFv†e Kiv nq Zv e`vL`v Ki†Z cvi †e Ges G m=úmkZ mgm`v mgravb Ki†Z cvi †e <p data-bbox="653 672 772 703">g†b†c†kR</p> <ol data-bbox="653 708 1131 1055" style="list-style-type: none"> <li data-bbox="653 708 1131 812">3. weifbœ† j e`envi K†i AvqZvKvi I eM†Kvi †ÿ††i `N`cwi gvc K†i †ÿ†dj wbYq Ki†Z cvi †e <li data-bbox="653 816 1131 881">4. IRb cwi g†ci weifbœcwi gvcK e`envi K†i cwi gvc Ki†Z cvi †e <li data-bbox="653 886 1131 984">5. Zij c`vt_Ŧ AvqZb cwi g†ci weifbœ cwi gvcK e`envi K†i cwi gvc Ki†Z cvi †e <li data-bbox="653 989 1131 1055">6. `b`b Rxe†b AvbgwibK cwi gvc Ki†Z cvi †e 	<p data-bbox="1152 272 1608 342">cZ`vkv Kiv hvq th, Aa`vq tk†l wkÿv_xfv- eÿ×eËxq</p> <ol data-bbox="1152 347 1608 521" style="list-style-type: none"> <li data-bbox="1152 347 1608 521">1. †`kxq, we†Uk I AvšR†ZK cwi gvc c×wZ e`vL`v Ki†Z cvi †e Ges ms†kó c×wZi mrv†h` `N`, †ÿ†dj, IRb I Zij c`vt_Ŧ AvqZb msew† Z mgm`vi mgravb Ki†Z cvi †e <p data-bbox="1152 626 1272 657">g†b†c†kR</p> <ol data-bbox="1152 662 1608 766" style="list-style-type: none"> <li data-bbox="1152 662 1608 766">2. †`kxq, we†Uk I AvšR†ZK c×wZ†Z `b`b Rxe†b c††j Z cwi gvc†Ki mrv†h` cwi gvc Ki†Z cvi †e 	<p data-bbox="1629 272 1934 342">cZ`vkv Kiv hvq th, `†i tk†l wkÿv_xfv- eÿ×eËxq</p> <ol data-bbox="1629 380 1976 521" style="list-style-type: none"> <li data-bbox="1629 380 1976 521">1. cwi g†ci weifbœ c×wZ eY†v Ges `b`b Rxe†b Gi e`envi m=úmkZ mgm`ve†j i mgravb Ki†Z cvi †e <p data-bbox="1629 662 1749 693">g†b†c†kR</p> <ol data-bbox="1629 698 1976 766" style="list-style-type: none"> <li data-bbox="1629 698 1976 766">2. `b`b Rxe†b weifbœc×wZ†Z cwi gvc Abgvb Ki†Z cvi †e 		

Ió tkóv	ZZxq Aa'vq	mBg tkóv	Aóg tkóv	cúšK wLbdj
<p>cZ'vkv Kiv hvq th, Aa'vq tkł</p> <p>wkýv_ŕv-</p> <p>ep'eĚxq</p> <ol style="list-style-type: none"> 1. cYmsL'vi ag'e'vL'v KiłZ cvi te 2. cYmsL'v kbr³ KiłZ cvi te 3. msL'vŁi Lvq cYmsL'vi Ae'vb ł' LvłZ cvi te Ges łQvU-eo msL'v Zj br KiłZ cvi te 4. wP'yh³ msL'vi thvM ł wełqvm KiłZ cvi te 5. msL'vŁi Lvi mrvvŁh' thvM ł wełqvm ł' LvłZ cvi te 				<p>cZ'vkv Kiv hvq th, ĩi tkł</p> <p>wkýv_ŕv-</p> <p>ep'eĚxq</p> <ol style="list-style-type: none"> 1. cYmsL'v ł wP'yh³ msL'vi 'emkó' e'vL'v Kłi cŁqvm KiłZ cvi te

Iô tkôv	PZL Aa'vq	mBg tkôv	PZL Aa'vq	Aóg tkôv	côšK wLbdj
<p>cĹ'vkv Kiv hvq th, Aa'vq tkł wkŷv_xŷv- eyxexq</p> <ol style="list-style-type: none"> 1. exRMwYZxq cĹxK, Pj K, mnM, mPK e'envi Kti MmYwZK mgm'v mgvavb KiłZ cviłe 2. exRMwYZxq iwki m`k l mem`k c` kbr³ KiłZ cviłe 3. GK ev GKwaK c` wewkó exRMwYZxq iwki eYŲv KiłZ cviłe 4. exRMwYZxq iwki thvM l wełqvM KiłZ cviłe <p>Avtelhq</p> <ol style="list-style-type: none"> 5. exRMwYłZi cĹZ AvMŲx nłe 		<p>cĹ'vkv Kiv hvq th, Aa'vq tkł wkŷv_xŷv- eyxexq</p> <ol style="list-style-type: none"> 1. exRMwYZxq iwki ŷ Y l fvm KiłZ cviłe 2. eŲbx e'envi i gra'tg exRMwYZxq iwki thvM, wełqvM, ŷ Y l fvm mspvšl`b w`b Rxełbi mgm'vi mgvavb KiłZ cviłe <p>Avtelhq</p> <ol style="list-style-type: none"> 3. exRMwYZxq mgm'v mgvavb AvMŲx nłe 			<p>cĹ'vkv Kiv hvq th, ŷi tkł wkŷv_xŷv- eyxexq</p> <ol style="list-style-type: none"> 1. exRMwYZxq iwki eYŲv KiłZ cviłe Ges exRMwYZxq cĹxK, Pj K, mnM, mPK, wPŷh³ msl'v BZ'w i gra'tg Zv cĹkv KiłZ cviłe 2. exRMwYZxq iwki thvM, wełqvM, ŷ Y l fvm KiłZ cviłe Ges GZ' mspvšl mgm'vi mgvavb KiłZ cviłe <p>Avtelhq</p> <ol style="list-style-type: none"> 3. exRMwYłZi mł_ cwi wPZ nłq exRMwYZxq mgm'v mgvavb AvMŲx nłe

Iô tkôv	mBg tkôv	cĀg Aa'vq	Aóg tkôv	PZL Aa'vq	côšK wLbdj
	<p>cĹ'vkv Kiv hvq th, Aa'vq tkł wkŷv_xŷv- eyxexq</p> <ol style="list-style-type: none"> 1. eM'wbYŲq exRMwYZxq mł'i eYŲv l cĹqvM KiłZ cviłe 2. exRMwYZxq mł' l Abymxvšl cĹqvM Kti iwki gvb wbYŲ KiłZ cviłe 3. exRMwYZxq mł' cĹqvM Kti Drcv`łK wełkd Y KiłZ cviłe 4. ŷ YbxqK l ŷ wYZK Kx Zv e'vL'v KiłZ cviłe 5. AbaŲ' wZbwJ exRMwYZxq iwki mvsuLK mnMmn M.mv. ŷ l j.mv. ŷ wbYŲ KiłZ cviłe 		<p>cĹ'vkv Kiv hvq th, Aa'vq tkł wkŷv_xŷv- eyxexq</p> <ol style="list-style-type: none"> 1. exRMwYZxq mł' cĹqvM Kti wĹc`x l wĹc`x iwki eM'wbYŲ, mij xKiY l gvb wbYŲ KiłZ cviłe 2. exRMwYZxq mł' cĹqvM Kti wĹc`x l wĹc`x iwki Nb wbYŲ, mij xKiY l gvb wbYŲ KiłZ cviłe 3. ga'c` wełkdłYi mvrvłh iwkgvj vi Drcv`K wełkd Y KiłZ cviłe 4. exRMwYZxq iwkgvj vi M.mv. ŷ l j.mv. ŷ wbYŲ KiłZ cviłe 		<p>cĹ'vkv Kiv hvq th, ŷi tkł wkŷv_xŷv- eyxexq</p> <ol style="list-style-type: none"> 1. exRMwYłZi cĹg PviwJ ełMŲ mł' l Nbdłji mł' eYŲv KiłZ cviłe Ges G'łjv cĹqvM exRMwYZxq iwki gvb wbYŲ KiłZ cviłe 2. exRMwYZxq iwki Drcv`łK wełkd Y KiłZ cviłe Ges M.mv. ŷ l j.mv. ŷ wbYŲ KiłZ cviłe

Ió tkóv	mBsg tkóv	Ió Aa`vq	Aóg tkóv	cĀg Aa`vq	cĀŠK ĩkLbdj
	cĀ`vkv Kiv hvq th, Aa`vq tkłI ĩkŷv_Ńv- eĵeĒxq 1. exRMŲZxq fMusk Kx Zv e`vL`v KiłZ cviłe 2. exRMŲZxq fMuskłK jNłKiY I mrvaiY niĳekó KiłZ cviłe 3. exRMŲZxq fMuskłki thvM, ĳetqvm Ges mij KiłZ cviłe		cĀ`vkv Kiv hvq th, Aa`vq tkłI ĩkŷv_Ńv- eĵeĒxq 1. exRMŲZxq fMuskłki thvM ĳetqvm, ŷY I fvM KiłZ cviłe Ges GZ`mspvsł mij I mgm`vi mgravb KiłZ cviłe		cĀ`vkv Kiv hvq th, ĩfi tkłI ĩkŷv_Ńv- eĵeĒxq 1. exRMŲZxq ĳwki fMuskłki aviYv e`vL`v Kłi Gł`i thvM, ĳetqvm, ŷY I fvM KiłZ cviłe Ges GZ`mspvsł mgm`vi mgravb KiłZ cviłe

Ió tkóv	cĀg Aa`vq	mBsg tkóv	mBsg Aa`vq	Aóg tkóv	Ió Aa`vq	cĀŠK ĩkLbdj
cĀ`vkv Kiv hvq th, Aa`vq tkłI ĩkŷv_Ńv- eĵeĒxq 1. mgxKiY I mij mgxKiY e`vL`v KiłZ cviłe Ges mgravb KiłZ cviłe 2. ev`é mgm`vi wfvĒłZ mgxKiY MVb Kłi mgravb KiłZ cviłe		cĀ`vkv Kiv hvq th, Aa`vq tkłI ĩkŷv_Ńv- eĵeĒxq 1. mgxKiłYi cŷvšli ĳeĳa, eRb ĳeĳa, Avo ŷb ĳeĳa , cĀZmvq` ĳeĳa e`vL`v KiłZ cviłe 2. ĳeĳamgn cĀqvm Kłi mgxKiłYi mgravb KiłZ cviłe 3. mij mgxKiY MVb I mgravb KiłZ cviłe 4. tj LwPł Kx Zv e`vL`v KiłZ cviłe głbvłcłkR 5. tj LwPłĀ Aqł I mĵeavRbK GKK ĳbłq ĳe`ŷvZb KiłZ cviłe 6. tj LwPłĀi mrvłth` mgxKiłYi mgravb KiłZ cviłe		cĀ`vkv Kiv hvq th, Aa`vq tkłI ĩkŷv_Ńv- eĵeĒxq 1. mgxKiłYi cłZ`vcb cŷvłZ I Acbqb cŷvłZ e`vL`v KiłZ cviłe 2. `B Pj Kłekó mij mnmgxKiY mgravb KiłZ cviłe 3. MŲvłZK mgm`vi mij mnmgxKiY MVb Kłi mgravb KiłZ cviłe głbvłcłkR 4. mij mnmgxKiłYi mgravb tj LwPłĀ ł`LvłZ cviłe 5. tj LwPłĀi mrvłth` mij mnmgxKiłYi mgravb KiłZ cviłe AvłelMxq 6. mnR mgm`v mgravłbi Rb` mgxKiY MVłb AvMłx nłe		cĀ`vkv Kiv hvq th, ĩfi tkłI ĩkŷv_Ńv- eĵeĒxq 1. mij mgxKiY I mij mnmgxKiY MVb Ges mgravb KiłZ cviłe głbvłcłkR 2. h_vh_fvłe QK KvMR e`envi Kłi tj LwPł Ałb KiłZ cviłe 3. mij mgxKiY I mij mnmgxKiłYi mgravb tj LwPłĀ ł`LvłZ cviłe 4. tj LwPłĀi mrvłth` mij mnmgxKiłYi mgravb KiłZ cviłe AvłelMxq 5. exRMŲZxq mgxKiY MVb Kłi mnR mgm`v mgravłbi AvMłx nłe

Iô tkôv	mBq tkôv	Aóg tkôv	mBq Aa'vq	côšK wLbdj
		<p>cĹ'vkv Kiv hvq th, Aa'vq tkĹ wk'ýv_xPv- ey'eĚxq</p> <ol style="list-style-type: none"> 1. tmU I tmU MVb cĹ'qv e'vL'v KiĹZ cviĹe 2. mmxg tmU, mweR tmU, cĹK tmU, cvkKv tmU, wĹt'Ĺ' tmU eYĹv KiĹZ cviĹe Ges Zv' i MVb cĹZxĹKi mvrĹth' cĹKvK KiĹZ cviĹe 3. GKwaK tmĹUi msthvM tmU I tQ' tmU MVb I e'vL'v KiĹZ cviĹe 4. t'fbwPĹ I D'vniĹYi mvrĹth' tmU cĹ'qv mnr ag'ewj hvPvB I cĹY KiĹZ cviĹe 5. tmĹUi ag'ewj cĹ'qvM KĹi mgm'v mgra'v KiĹZ cviĹe <p>AvĹeMxq</p> <ol style="list-style-type: none"> 6. t'fbwPĹĹi mvrĹth' MwywZK mgm'vK b'w'wbKfvĹe Dc'vcĹb mĹPó nĹe 	<p>cĹ'vkv Kiv hvq th, 'Ĺi tkĹ wk'ýv_xPv- ey'eĚxq</p> <ol style="list-style-type: none"> 1. D'vniY I cĹZxĹKi mvrĹth' tmU e'vL'v KiĹZ cviĹe Ges tmU cĹ'qv e'envĹi gva'tg we'f'be mgm'vi mgra'v KiĹZ cviĹe <p>AvĹeMxq</p> <ol style="list-style-type: none"> 2. tmĹUi mvrĹth' Z'ĹK b'w'wbKfvĹe Dc'vcĹb mĹPó nĹe 	

Ió tkóv	mBg Aa`vq	mBg tkóv	Aóg Aa`vq	Aóg tkóv	cúšK wLbdj
	cĹ`vkv Kiv hvq th, Aa`vq tkł wkŷv_xŲv- eyxexq 1. GKilU wbu` 0 ti LvskłK cui gvc KiłZ cvi te 2. cĹ`E Z` e`envi Kłi ti Lvsk A¼b KiłZ cvi te 3. wewfbogvłci łKvłYi wPĪ A¼b KiłZ cvi te	cĹ`vkv Kiv hvq th, Aa`vq tkł wkŷv_xŲv- eyxexq 1. mgyšlivj mij łi Lv l łQ`K 0iv Drcbe łKvłYi `enkó` e`vL`v KiłZ cvi te 2. `BwU mij łi Lv mgyšlivj nl qvq kZ`eY0v KiłZ cvi te			cúšK wLbdj cĹ`vkv Kiv hvq th, `i tkł wkŷv_xŲv- eyxexq 1. mgyšlivj mij łi Lv l łQ`K 0iv Drcbe łKvłYi `enkó` eY0v l cłqvM KiłZ cvi te

Ió tkóv	mBg tkóv	beg Aa`vq	Aóg tkóv	beg Aa`vq	cúšK wLbdj
	cĹ`vkv Kiv hvq th, Aa`vq tkł wkŷv_xŲv- eyxexq 1. wĪ fłRi Ašł` l eint`łKvY eY0v KiłZ cvi te 2. wĪ fłRi tğšuj K Dccv`_łjv c0vY KiłZ cvi te 3. wĪ fłRi evú l łKvłYi cvi`úwi K m`úK`e`envi Kłi RxebvfwEK mgm`vi mgravb KiłZ cvi te głbvłcwkR 4. wewfbakZřvłcłjy wĪ fR AvKłZ cvi te 5. wĪ fR łjyłi fvg l D`PZv tğc łjyłdj cui gvc KiłZ cvi te		cĹ`vkv Kiv hvq th, Aa`vq tkł wkŷv_xŲv- eyxexq 1. wc_vłMvivłmi Dccv` hvPvB Kłi e`vL`v KiłZ cvi te 2. wĪ fłRi wZbwU evú i %N0` l qv`vKłj wĪ fRwU mgłKvYx wKbv-hvPvB KiłZ cvi te 3. wc_vłMvivłmi Dccv` c0vY KiłZ cvi te 4. wc_vłMvivłmi mĪ e`envi Kłi mgm`v mgravb KiłZ cvi te		cúšK wLbdj cĹ`vkv Kiv hvq th, `i tkł wkŷv_xŲv- eyxexq 1. wĪ fłRi `enkó` e`vL`v KiłZ cvi te Ges wĪ fRmšvšł tğšuj K Dccv` c0vY Kłi cłqvM KiłZ cvi te głbvłcwkR 2. cĹ`E Zł`i wfwEłZ wĪ fR A¼b KiłZ cvi te Avłellq 3. wĪ fR mšvšł mgm`v mgravłbi gva`tg thšv`K wPšłq D0x nte

Ió tkóv	mBg tkóv	kg Aa'vq	Aóg tkóv	cúšK wLbdj
	<p>cĹ'vkv Kiv hvq th, Aa'vq tkłl wkyv_xfv- eꝑeĚxq</p> <ol style="list-style-type: none"> 1. weirfbæR'wguZK AvKvi AvKwZ ntZ meŋg Ges m`k AvKvi AvKwZ wPwYz KiłZ cvi te 2. meŋg I m`kZvi gta' cv_R' KiłZ cvi te 3. wbw`Ŧ 'enkto'i Avtj vtK wĪ fR I PZfRi m`kZv e'vL'v KiłZ cvi te 4. wbw`Ŧ 'enkto'i wfvĚłZ wĪ fĪRi meŋgZv cġvY KiłZ cvi te 5. meŋgZv I m`kZvi 'enkto'i wfvĚłZ mnR MwYwZK I er'le mgm'vi mgvab KiłZ cvi te 			<p>cĹ'vkv Kiv hvq th, ĩi tkłl wkyv_xfv- eꝑeĚxq</p> <ol style="list-style-type: none"> 1. meŋgZv I m`kZvi 'enkó' e'vL'v Kłi tgšwJ K Dccv' cġvY Ges mgm'v mgvab KiłZ cvi te

Ió tkóv	mBg tkóv	Aóg tkóv	Aóg Aa'vq	cúšK wLbdj
		<p>cĹ'vkv Kiv hvq th, Aa'vq tkłl wkyv_xfv- eꝑeĚxq</p> <ol style="list-style-type: none"> 1. PZfRi agŋej hvPvB KiłZ cvi te 2. PZfRi agŋej i hv³gj K cġvY KiłZ cvi te <p>gtbwčwK R</p> <ol style="list-style-type: none"> 3. cĹĚ DcvĚ ntZ iaj vi I K=úm e'envi Kłi PZfR AvKłZ cvi te 4. wĪ fR mĪłi mnvth' PZfR týtłi týtłdj cwi gvc KiłZ cvi te 5. PZfR týtłi týtłdj cwi gvc KiłZ cvi te 6. AvqZvKvi Nbe' I NbtKi týtłdj cwi gvc KiłZ cvi te 		<p>cĹ'vkv Kiv hvq th, ĩi tkłl wkyv_xfv- eꝑeĚxq</p> <ol style="list-style-type: none"> 1. PZfRi agŋej e'vL'v KiłZ cvi te Ges MwYwZK Dv' i mZ'Zv hvPvB, cġvY I cĹqM KiłZ cvi te <p>gtbwčwK R</p> <ol style="list-style-type: none"> 2. h_vh_ cwi gvcK e'envi Kłi AvqZvKvi Nbe' I NbtKi týtłdj cwi gvc KiłZ cvi te

Ió tkóv	mBq tkóv	Aóg tkóv	kg Aa'vq	cúsk wLbdj
		<p>cZ'vkv Kiv hvq th, Aa'vq tkłl wkyv_xpv-eyxeE'xq</p> <ol style="list-style-type: none"> 1. eE'Éi avi Yv jvf Kite 2. cvB(π) Gi avi Yv e'vL'v KitZ cvi te 3. eE'vKvi tyt'íi ty'Ídj I cwi mxgv wbyE' Kti mgm'v mgravb KitZ cvi te 4. eE' mspvš'í Dccv'' cōvY KitZ cvi te 5. eE' mspvš'í Dccv'' cōqvM Kti mgm'v mgravb KitZ cvi te <p>g'btvc'kR</p> <ol style="list-style-type: none"> 6. cwi gvcK wdzv e'envi Kti eE'vKvi tyt'íi cwi mxgv I ty'Ídj cwi gvc KitZ cvi te 7. tej tbi cōi ty'Ídj cwi gvc KitZ cvi te 		<p>cZ'vkv Kiv hvq th, 'íi tkłl wkyv_xpv-eyxeE'xq</p> <ol style="list-style-type: none"> 1. eE' mspvš'í tgš'ij K Dccv'' cōvY KitZ cvi te Ges GZ' m'úwKZ mgm'v mgravb KitZ cvi te <p>g'btvc'kR</p> <ol style="list-style-type: none"> 2. h_vh_ cwi gvcK e'envi Kti tKvYK I tej tbi cōi ty'Ídj cwi gvc KitZ cvi te

Ió tkóv	Aóg Aa'vq	mBq tkóv	GKv`k Aa'vq	Aóg tkóv	GKv`k Aa'vq	cúsk wLbdj
<p>cZ'vkv Kiv hvq th, Aa'vq tkłl wkyv_xpv-eyxeE'xq</p> <ol style="list-style-type: none"> 1. Z_ I DcvÉ Kx Zv e'vL'v KitZ cvi te 2. tkóv e'earb bv Kti Awb''í DcvÉ'Éi Mo, ga'K I cōi K wbyE' KitZ cvi te 3. Aw'Z tiLwP'íi eY'v KitZ cvi te <p>g'btvc'kR</p> <ol style="list-style-type: none"> 4. tiLwP'í Aw'b KitZ cvi te 		<p>cZ'vkv Kiv hvq th, Aa'vq tkłl wkyv_xpv-eyxeE'xq</p> <ol style="list-style-type: none"> 1. MYmsL'v mvi wY Kx Zv e'vL'v KitZ cvi te 2. tkóv e'earb'íi gra'tg Awb''í DcvÉ w'v'í AvKv'íi cKv'k KitZ cvi te 3. Aw'Z AvqZ'tj L n'tZ DcvÉ m'ú'K'e'vL'v KitZ cvi te 4. AvqZ'tj L n'tZ cōi K wbyE' KitZ cvi te <p>g'btvc'kR</p> <ol style="list-style-type: none"> 5. AvqZ'tj L Aw'b KitZ cvi te 		<p>cZ'vkv Kiv hvq th, Aa'vq tkłl wkyv_xpv-eyxeE'xq</p> <ol style="list-style-type: none"> 1. tKv' t cōYZv e'vL'v KitZ cvi te 2. M'vYvZK m'íi m'v'v'th Mo, ga'K I cōi K wbyE' Kti mgm'v mgravb KitZ cvi te <p>g'btvc'kR</p> <ol style="list-style-type: none"> 3. cvBw'P'í Aw'b KitZ cvi te 		<p>cZ'vkv Kiv hvq th, 'íi tkłl wkyv_xpv-eyxeE'xq</p> <ol style="list-style-type: none"> 1. Z_ I DcvÉ n'tZ Mo, ga'K, cōi K wbyE' Kti G m'úwKZ mgm'v mgravb KitZ cvi te 2. Aw'Z tj LwP'í'K e'vL'v KitZ cvi te <p>g'btvc'kR</p> <ol style="list-style-type: none"> 3. Z_-DcvÉ'K tj LwP'í cKv'k KitZ cvi te

5. Aa'vq veb'vm I vcviqW eEb

Aa'vq	I o tkW		mBg tkW		Aog tkW	
	Aa'vtqi bvg	vcvii qW msL'v	Aa'vtqi bvg	vcvii qW msL'v	Aa'vtqi bvg	vcvii qW msL'v
cog Aa'vq	~fweK msL'v I fMusk	15	gj` - Agj` msL'v	15	c'vUvb®	10
wZxq Aa'vq	AbpcvZ I kZKiv	25	mgvpcvZ I jvf-¶WZ	15	gpcv	15
ZZxq Aa'vq	cYmsL'v	15	cwi gvc	10	cwi gvc	10
PZL®Aa'vq	exRMwYZxq iwk	15	exRMwYZxq iwiki _Y I fW	10	exRMwYZxq m'vewj I c'qW	12
cAg Aa'vq	mij mgxKiY	15	exRMwYZxq m'vewj I c'qW	12	exRMwYZxq fMusk	8
I o Aa'vq	R'wgvZi tgvij K aviYv	20	exRMwYZxq fMusk	8	mij mnmgxKiY	10
mBg Aa'vq	e'enwii K R'wgvZ	25	mij mgxKiY	10	tmU	10
Aog Aa'vq	Z_ I DcvE	10	mgvšlij mij tiLv	15	PZfR	12
beg Aa'vq	-----	-----	wi fR	20	wc_vtMvivotmi Dccv`	23
`kg Aa'vq	-----	-----	m`kZv I mefigZv	15	eE	15
GKv`k Aa'vq	-----	-----	Z_ I DcvE	10	Z_ I DcvE	15

6. Ինքնուրույն ՕԿ

Լուծում

c0g Aa'vq : 'vfwek msL'v I fMusk (15 vcvii qW)

wKlbdj	vel qe'	wKlb-tkLvtbv vbt`Rbv	gj`vqb vbt`Rbv
<p>epxeExq</p> <ol style="list-style-type: none"> 1. 'vfwek msL'vi A¼civZb KitZ cvi te 2. t`kxq I AvSRwZK i xizZ A¼civZb Kti cotZ cvi te 3. tgšuj K msL'v, thšwMK msL'v I mntgšuj K msL'v wPyZ KitZ cvi te 4. wefvR`Zv e'vL'v KitZ cvi te 5. 2, 3, 4, 5, 9 0viv wefvR`Zv hvPvB KitZ cvi te 6. mvaviY fMusk I `kugK fMusk i M.mv. I j.mv., wYq KitZ cvi te 7. mvaviY fMusk I `kugK fMusk i mij xKiY Kti MwYwZK mgm'vi mgravb KitZ cvi te <p>AvtelMxq</p> <ol style="list-style-type: none"> 8. msL'v m'ufK tkSZaj x ntq wewfbrai tbi msL'wfwEK gRvi gRvi tLj vq Drmvnx nte 	<ul style="list-style-type: none"> • 'vfwek msL'v • t`kxq I AvSRwZK i xizZ A¼civZb • tgšuj K msL'v, thšwMK msL'v, mntgšuj K msL'v • wefvR`Zv • M.mv. I j.mv. • fMusk I `kugK msL'vi mij 	<ul style="list-style-type: none"> • wkyK D`vniYi mrvth' 'vfwek msL'v I ktb'i avi Yv t`teb • D`vniY I c0kueEii gra'tg At'vi 'vbxqgvtbi ceAvb hvPvB KitZ cvi te • wkyv_xPv tevWqKtqKuU msL'v wj tL Zv t`tK tgšuj K msL'v I thšwMK msL'v kbr³ KitZ cvi te tKvb tKvb msL'v ci`ui mntgšuj K Zv wYq KitZ wkyK mntghwMZv KitZ cvi te c0kueEii gra'tg wkyv_xPv i avi Yv cwi`vi KitZ cvi te • wkyK 2, 3, 5 0viv wefvR`Zvi ceAvb c0kueEii gra'tg hvPvB KitZ cvi te 4 I 9 0viv wefvR` msL'v t'v D`vniY I c0kueEii mrvth' e'vL'v KitZ cvi te Ges wewfbomsL'v w'tg wefvR`Zv hvPvB KitZ cvi te wkyv_xPv `j xqfite 2, 3, 4, 5, 9 Gi wefvR`Zvi wbgg t'v QK AvKviti Dc`vcb KitZ cvi te • wkyK 'vfwek msL'vi M.mv. I j.mv. wYq c'wZ c0kueEii gra'tg hvPvB KitZ cvi te mvaviY fMusk I `kugK fMusk i M.mv. I j.mv. wYq c'wZ D`vniYi mrvth' tevSvteb Ges wkyv_xPv i M.mv. I j.mv. wYq KitZ t`teb • wkyK wewfbocKvi eÜbxi bvg wPymn LuZvq wj tLZ cvi te mij xKitY eÜbxi e'envi c0kueEii gra'tg hvPvB KitZ cvi te mvaviY fMusk I `kugK fMusk i mij xKitY thwM, wetaM, Y, fM, Gi I eÜbxi KvR chqutg eYv Kti GKRb wkyv_xK tevWqGKuU mnR mij KitZ t`teb Ges cv'cyfKti Abkxj bxi mgm'v `j MZfite mgravb KitZ cvi te • wkyK wkyv_xPv i `j MZfite 3, 4, 5, 6 At'vi msL'v e'envi Kti 2, 3, 5 0viv wefvR` msL'v wYq Kivi c0ZthwMZvi e'e`v KitZ cvi te Gfite wkyv_xPv tLj vi gra'tg wefvR`Zv hvPvB KitZ cvi te 	<ul style="list-style-type: none"> • tevWqA¼civZb KitZ w'tg chfeyt'vi gra'tg gj`vqb KitZ cvi te • wkyK emoi KvR I tk'vi KvRi gra'tg gj`vqb KitZ cvi te • QK Dc`vcb Kivi mgq wkyv_xPv i Dc`vcb tkSkj gj`vqb KitZ cvi te • tk'v Awf'vi gra'tg gj`vqb KitZ cvi te • wba'v Z grb`te mrvth' `j MZ KvR gj`vqb KitZ cvi te • wkyv_xPv i tLj vi gra'tg msL'vi wefvR`Zv wYq c0Z tkSZaj I `tj KvR Kivi gbwMKZv gj`vqb KitZ cvi te

PZL ©Aa`vq : exRMWYZxq i wk (15 wcnı qW)

wklbdj	welqe`	wklb-fklvrbv wbt` Rbv	gj`vqb wbt` Rbv
<p>ey`eE`xq</p> <p>1. exRMWYZxq cZxK, Pj K, mnM, mPK e`envi Kti MwYwZK mgm`v mgravb KitZ cvi te </p> <p>2. exRMWYZxq iwiki m`k l wem`k c` kbr³ KitZ cvi te </p> <p>3. GK ev GKwaK c` weikó exRMWYZxq iwk eYbv KitZ cvi te </p> <p>4. exRMWYZxq iwiki thvM l wetqwm KitZ cvi te </p>	<ul style="list-style-type: none"> • exRMWYZxq cZxK, Pj K, mnM l mPtKi e`envi • exRMWYZxq iwiki m`k l wem`k c`, GK ev GKwaK c` weikó exRMWYZxq iwiki eYbv • exRMWYZxq iwiki thvM l wetqwm 	<ul style="list-style-type: none"> • ARvbn msL`v wbyq KitZ wetkl cZxK (□) ev Ayi cZxK (K,L,...) e`envi m`utK`wkýv_ñ` i ce`aviYvi Dci wfwE Kti wkýK Ayi cZxtKi gvb th Pj gvb Zv e`vL`vi gva`tg exRMWYZxq Pj tKi aviYv`úo Kiteb wkýK exRMWYZxq mnM l mPtKi aviYv D`vniYmn e`vL`v Kiteb wkýv_ñv G m`umKZ mgm`vi mgravb Kite Ges c`qvrTb wkýK mnvqZv Kiteb • wkýv_ñv`j MZfite GKB RvZxq weifbAvKviti DcKiY t`tK m`k l wem`k DcKiY Avj`v`v Kti m`k e`i ag`m`utK` Rvte GKBfite exRMWYZxq m`k l wem`k c` Avj`v`v KitZ wklte c`qvrTb wkýK mnvqZv Kiteb • wkýv_ñ` i mnvqZvq wkýK exRMWYZxq i wkgj vi thvM l wetqwm teitw`Kti t` Lteb wkýv_ñv GZ`mspvsí c`ó E thvM l wetqwm Abkxj b Kite c`qvrTb wkýK mnvqZv Kiteb 	<ul style="list-style-type: none"> • c`kúE`ti i gva`tg gj`vqb Kiteb • mgm`v mgravb Kivi mgta wkýK ch`eyY Kti gj`vqb Kiteb • tkúvi KvR l tkúv Awf`yvi gva`tg gj`vqb Kiteb • ewoi KvRi mnvth` gj`vqb Kiteb • `j MZ KvRi mgq ch`ey`ti gva`tg wkýv_ñv exRMWYZi c`ó AvMbx wkbv-Zv gj`vqb Kiteb
<p>AvtelMxq</p> <p>5. exRMWYZi c`óZ AvMbx nte </p>			

cĀg Aa`vq : mij mgxKiY (15 vcn qW)

wklbdj	velqe`	wklb-fkLvfbv vbt` Rbv	gj`vqb vbt` Rbv
<p>ey`eĒxq</p> <p>1. mgxKiY I mij mgxKiY e`vL`v KiZ cvite Ges mgvavb KiZ cvite </p> <p>2. er`e mgm`vi wfvĒZ mgxKiY MVb Kti mgvavb KiZ cvite </p>	<ul style="list-style-type: none"> • mgxKiY I mij mgxKiYi eYĒv • mij mgxKiY MVb I mgvavb 	<ul style="list-style-type: none"> • wkyK mgxKiY I mij mgxKiYi avi Yv D`vniYmn e`vL`v KiZeb wkyv_Ē i mrvqZvq mij mgxKiYi mgvavb tevWĒKti t`Lvteb • wkytKi vbt` Ēk wkyv_ĒGKwU mgm`vi mgvavb tevWĒKite Abkxj bxi Ab`vb` mgm`v wkyv_Ēfv` j MZfvte mgvavb Kite wkyK cĒqvRtb mrvqZv KiZeb • wkyK er`e mgm`vi GKwU mgxKiY MVb Kti t`Lvteb wkytKi mrvqZvq wkyv_Ēfv mgxKiY MVb I mgvavb Kivi Abkxj b KiZeb 	<ul style="list-style-type: none"> • wkyv_Ē i tevWĒWĒK mij mgxKiYi mgvavb KiZ w`tq cĒkĒĒii mrvvth` gj`vqb KiZeb • vbaĒi Z gvb`ĒĒi mrvvth` `j MZ KvR gj`vqb KiZeb • tkĒvi KvR I ewoi KvRi mrvvth` gj`vqb KiZeb

I ô Aa`vq : R`vgnvZi tgnij K aviYv (20 vcnvqW)

wklbdj	vel qe`	wklb-iklvfbv vbt` Rbv	gj`vqb vbt` Rbv
<p>epxeEiq</p> <p>1. `vb, Zj, tiLv I we`y evL`v KiZ cvite </p> <p>2. mij tiLv, tiLusk I inkfi gta` cv_R` KiZ cvite </p> <p>3. mibunZ tkvY,tjvi m`uR evL`v I c`qvM KiZ cvite </p> <p>4. wecZxc tkvY,tjvi m`uR eYbv I c`qvM KiZ cvite </p>	<ul style="list-style-type: none"> • `vb, Zj, tiLv I we`y • tiLusk I inkfi, mij tiLv, ep tiLv • we`y tiLv, Zj m`uR KiqKw c`qvRbxq mZtmx • mij tkvY, mibunZ tkvY, m`uR tkvY, wecZxc tkvY • tiLv I tkvY m`uR Dccv` evL`v I hvPvB Dccv` • GKw tiLvstki c`ste` jZ AcI GKw tiLusk wgvj Z ntj th `Bw mibunZ tkvY Drcbanq, Gt` i mguo `B mgtkvY • `Bw mij tiLv ci`ui tQ` Kitj Drcbe wecZxc tkvY,tjv ci`ui mgvb 	<ul style="list-style-type: none"> • ev`e D`vniY thgb- tUvej, teA, eB, e- , BU, BZ`w i mrvth` wkyv_xfv `vb,Zj, tiLv I we`ym`uR Zv` i ce`aviYv evL`v Kite wkyK c`qvRtb mnthwMZv Kiteb • tevW`P` GtK Ges cke DE`ti mrvth` wkyv_xfv tiLv, tiLusk I inkfi evL`v Kite wkyv_xfv `j MZfvte tiLv, tiLusk I inkfi cv_R` QkvKvfi Dc`vcb Kite • wkyv_xfv KivR fvR Kti wKsev kvvKvi mrvth` mij tkvY, m`uR tkvY, mibunZ tkvY `Zwi Kti evL`v Kite wkyK tkvY `Zwi I evL`v KiZ mnvqZv Kiteb • wkyv_xfv weifbrai`bi mibunZ tkvY A`b Kti cwi gvc Kite Ges Zv`_tK Dccv` w m`uR w`v`S`DcbvZ nte c`qvRtb wkyK mnthwMZv Kiteb • wkyv_xfv weifbrai`bi wecZxc tkvY A`b Kti cwi gvc Kite Ges wecZxc tkvY,tjv th ci`ui mgvb Zv hvPvB Kite • t`j, eB, LvZv, teA ev tUvej i gj`Lvgl `Bavi I tijj vB`bi Onei mrvth` wkyK mgv`ilvj mij tiLv, tQ` K Ges Drcbe tkvYmg`ni aviYv `uo Kiteb cvkvcwk `BRb wkyv_xfv mgv`ilvj mij tiLv I tQ`_tKi weifbrai`bi A`b Kite wkyv_xfv ci`ui`i mvt_ Avtj vPbv Kti GKv`li tkvY I Abje tkvY wpyZ Kti evL`v Kite wkyK c`qvRtb mnvqZv Kiteb 	<ul style="list-style-type: none"> • wkyv_xfv ev`e D`vniY thgb- tUvej, teA, eB, e- , BU BZ`w i mrvth` `vb, Zj, tiLv I we`ym`uR Zv` i ce`aviYv evL`v Kivi mgq wkyK chfeyY Kti gj`vqb Kiteb • tiLv, tiLusk I inkfi cv_R` QkvKvfi Dc`vcb Kivi mgq tgnwLK thvMthwM `yZv gj`vqb Kiteb • vba`iZ gvb`te`i mrvth` `j MZ KvR gj`vqb Kiteb • c`kve`ti i gra`tg gj`vqb Kiteb • wkyv_xfv tRovq kvR Kivi mgq wkyK chfeyY Kiteb Ges wkyv_xfv i mnthwMZv gj`K gtbv`ve gj`vqb Kiteb • tkvYi kvR I tkvY Avf`yvi gra`tg gj`vqb Kiteb

I ô Aa`vq : R`wguZi tğšij K aviYv (20 wciwqW)

wklbdj	wcl qe`	wklb-ıtklvfbv wbt` Rbv	gjj`vqb wbt` Rbv
<p>5. mgušijv tiLv eYØv KiİZ cviİe </p> <p>6. `βwU mgušijv mijİtiLv I GKwU tQ`K Øviv Drcbæ tKvYmga eYØv I cØqvM KiİZ cviİe </p> <p>7. evütİfİ` I tKvYİfİ` wİ fR e`vL`v KiİZ cviİe </p> <p>8. eM`AvqZ, i`aİ I mvgvšİi K wPıyZ KiİZ cviİe </p>	<ul style="list-style-type: none"> • mgušijv mijİtiLv • evütİfİ` I tKvYİfİ` wİ fR (mgevü wİ fR, mguØevü wİ fR, wcl gevü wİ fR, mÿ#KvYx wİ fR, İj tKvYx wİ fR, mgtKvYx wİ fR m`uıwKØ e`vL`v Ges G İj vtK wPıyZ KiİZ cviİi Rb` mnR mgm`v) • eM`AvqZ, i`aİ I mvgvšİi K 	<ul style="list-style-type: none"> • wkyK wvrfbaıİtİbi wİ fİRi wPİ I GKwU QK cØZwU İj mieivn Kiİeb wkyv_xPv wİ fİRi evü I tKvY İj v cwi gvc Kİi İj MZfvİte QKwU ciY Kiİe wkyK ciYKZ QİKi graİg wkyv_xP i evütİfİ` I tKvYİfİ` wİ fİRi aviYv cwi`vi Kiİeb • wkyv_xPv tRıvıq tRıvıq Zİf`i R`wguZ eİ` İvKv 30⁰-60⁰-90⁰ grİci `βwU İmU İ`qvı mwiRİq GKwU AvqZ İZwi Kiİe wkyK AvqZwU tKvY I evüi İenkó` wkyv_xP i ejİZ ejİeb cØqvRİb wkyK mnİhwMZv Kiİeb Abıycfvİte, 30⁰-60⁰-90⁰ I 45⁰-45⁰-90⁰ grİci İmU İ`qvİi mıvıİh` eM`i`aİ I mvgvšİi K İZwi Kiİe Ges Zİf`i İenkó` İj v ej İe cØqvRİb wkyK mnıvqZv Kiİeb 	

mβg Aa`vq : e`enwi K R`wguZ

(25 vcuu qW)

wKLbdj	weI qe`	wKLb-`tkLvfbv wbt` Rbv	gj`vqb wbt` Rbv
<p>ey`eE`xq</p> <p>1. GKwU wbu`θ ti LvstK cwi gvc KitZ cvi`te </p> <p>2. c0E Z` e`enwi Kti ti Lvsk A¼b KitZ cvi`te </p> <p>3. weifbvgv`ci tKvYi wP` A¼b KitZ cvi`te </p>	<ul style="list-style-type: none"> • ti Lvstki cwi gvc • ti Lvsk m`uukZ A¼b <ul style="list-style-type: none"> ○ GKwU wbu`θ cwi gvtci ti Lvsk ○ GKwU wbu`θ ti Lvstki mgiuLEK ○ GKwU wbu`θ ti Lvstki ASt` tKvfbv we`jZ j`^ ○ GKwU wbu`θ ti Lvstki eint` tKvfbv we`yntZ j`^ • tKvY m`uukZ A¼b <ul style="list-style-type: none"> ○ m`z`tkvY, `j`tkvY, mgtKvY, mubmZ tkvY, c`K tkvY, m`u`K tkvY, mij tkvY ○ K`uvm e`enwi Kti wbu`θ cwi gvtci tKvY ○ c0E tKvYi mgvb Kti tKvY ○ GKwU wbu`θ tKvYi mgiuLEK 	<ul style="list-style-type: none"> • wkyK wbt` Rbv c0vb Kti wkyv_x` i textW`WtK weifbve R`wguZK A¼b Kit`eb Gfite KtqKRb wkyv_x` i w`tq textW`Kivbvi ci c0Z`K wkyv_x` c0E wbt` Rbv Abhvqx LvZvq A¼b Kit`eb wkyK c0qvRbxq mnthwMZv Kit`eb 	<ul style="list-style-type: none"> • wkyv_x` i textW`WtK R`wguZ e`enwi Kti AwKtZ w`tq gj`vqb Kit`eb • tkvYi KvR w`tq wbu`θ gvb`tEi wfvE`Z gj`vqb Kit`eb • ewoi KvRi mivth` gj`vqb Kit`eb

Aóg Aa'vq : Z_ I DcvĒ (10 wci qW)

wLbdj	wLqe'	wLb-ikLvfv wbt`Rbv	gj`vqb wbt`Rbv
<p>epxeĒwq 1. Z_ I DcvĒ Kx Zv e'vL'v KiZ cvi te 2. tkŌY e'earb bv Kti Aweb''Í DcvĒi Mo, ga`K I cŌi K wbyĒ KiZ cvi te 3. Aw4Z ti LwPĒi eYŌv KiZ cvi te </p> <p>gġbvtcukR 4. ti LwPĒ A4b KiZ cvi te </p>	<ul style="list-style-type: none"> • Z_ I DcvĒ • Aweb''Í DcvĒ t_ġK Mo, ga`K I cŌi K wbyĒ • DcvĒġK ti LwPĒġ cKvk 	<ul style="list-style-type: none"> • wkyK KġqKRb wkyv_Ō Kj g mslMŌ Kti Gt`i μqgj` tevŲW wj ġL cŌkŌĒġi gva'ġg Z_ I DcvĒi avi Yv t`teb • Kj ġgi tgvU gj`ġK Kj ġgi msL'v w'ġg fVM KiZ ej teb Ges μqgj` μg Abynvġi mwiRġg ga`K I cŌi ġKi avi Yv e'vL'v KiZ eb • Aweb''Í DcvĒi Mo, ga`K I cŌi K wbyĒqi cxwZ eYŌv KiZ eb Ges MwYwZKfvte Mo, ga`K, cŌi K wbyĒ KiZ ej teb wkyv_Ō i eqm ev D'PZvi Z_ mslMŌ Kti Mo, ga`K, cŌi K wbyĒ Kivi wbt`Rbv t`teb • wkyK cġPRb wkyv_ŌK tevŲW mvgtb mwi exfvte `wo Kwi ġg Zv`i D'PZv eivei we`y, ġj v wPwYZ KiZ eb Ges chŌqμġg thvM Kti ti LwPĒi avi Yv t`teb wkyK ti LwPĒ A4tbi eYŌv KiZ eb wkyv_Ōv ti LwPĒ A4tbi Abkxj b KiZ eb • wkyv_Ōv tkvfv cixyvq cŌB b'ġi ti LwPĒ A4b Kti e'vL'v KiZ eb 	<ul style="list-style-type: none"> • tkŌYi KvR w'ġg wŌv`Ō gvb`ġŌi wfvĒZ gj`vqb KiZ eb • wkyv_Ō i GKKfvte LvZvq mgm'v mgravb KiZ w'ġg gj`vqb KiZ eb • wkyv_Ō i tevŲWġWġK ti LwPĒ AwKġg w'ġg gj`vqb KiZ eb • tkŌY AwfYvi gva'ġg gj`vqb KiZ eb • ewŌi KvRi mwi'fh` gj`vqb KiZ eb

7. tj LK wbt` Rbv

c0g Aa`vq : `vfweK msL`v I fMusk

1. A¼ cvZb Ges t` kxq I AvSRwZK MYbv i wZi Avtj vPbv _vKte|
2. tgšuj K msL`v, thšMK msL`v I mntgšuj K msL`vi eYθvi cpivtj vPbv _vKte|
3. 2, 3 I 5 θviv wefvR`Zv cpivtj vPbv cvRj I tMgtmi gva`tg _vKte |
4. 4 I 9 θviv wefvR`Zv wkjv`xKw`K Kvhβtgi gva`tg D`vniYmn e`vL`v _vKte |
5. `vfweK msL`vi M.mv. . I j .mv. . wBYθ c×wZi cpivtj vPbv _vKte|
6. mvariY fMusk I `kugK fMusk i D`vniY I e`vL`v _vKte|
7. fMusk I `kugK msL`vi eÜbx e`envi Kti mitj i wbgq D`vniYi mnvth` eYθv _vKte|
8. fMusk I `kugK fMusk Gi M.mv. . I j .mv. ., mij xKiY Ges MwYwZK mgn`vi D`vniY I Abkxj bx _vKte|

w0Zxq Aa`vq : AbcvZ I kZKiv

1. AbcvZi e`vL`v w`tz nte|
2. mij AbcvZ, e`vI AbcvZ, wgk0AbcvZ D`vniYmn e`vL`v _vKte|
3. kZKivK mvariY fMusk Ges fMuskK kZKivq cKvk Kivi c×wZi cpivtj vPbv _vKte|
4. HwKK wbgq I kZKiv wnmvtei eYθv D`vniYmn _vKte|
5. HwKK wbgq I kZKiv wnmvtei mnvth` mgq I KvR, mgq I Lv`, mgq I `tZj welqK MwYwZK mgn`vi D`vniY I Abkxj bx _vKte|

ZZxq Aa`vq : cYmsL`v

1. cYmsL`vi aviYv I `ewk0` msL`vKiWθ(Number Card) I msL`v ti Lvi (Number Line) mnvth` e`vL`v _vKte|
2. tLjvi gva`tg cYmsL`v kbv3KiYi eYθv _vKte|
3. msL`v ti Lvq wKfvte cYmsL`v emvZ nq Ges t0vU-eo Zj bv KiZ nq Zvi e`vL`v _vKte|
4. wPyhβ msL`vi thvM I wetaqM i wbgq D`vniYmn e`vL`v _vKte|
5. msL`v ti Lvq msL`vi Ae`vb Ges msL`v ti Lvi mnvth` thvM I wetaqM c0μqvi eYθv _vKte|
6. Abkxj bx _vKte|

PZL Aa`vq : exRMWZxq iwk

1. msL`vi cwi e`fZ`exRMWZxq cZxK, Pj K e`envi Kivi c`wZi e`vL`v`vKte |
2. exRMWZxq iwk, mnM, mPK, m`k I wem`k c` D`vniYmn e`vL`v`vKte |
3. exRMWZxq iwiki thvM, wetqvtMi wqvtgi D`vniYmn eY`v Ges Abkxj bx`vKte |

cAg Aa`vq : mij mgxKiY

1. GKwJ AAvZ iwk wwkó mij mgxKiYi e`vL`v`vKte |
2. mij mgxKiYi mgvavtbi wqvg D`vniYmn eY`v`vKte |
3. ev`e mgm`vi wfiE`fZ` mgxKiY Mvb Ges mgvavtbi e`vL`v`vKte |
4. Abkxj bx`vKte |

Ió Aa`vq : R`vgnvZi tgsj K aviYv

1. ev`e D`vniY I wP`fI mrvvth` `vb, Zj, tiLv, I w`y`j cpivtj vPbv`vKte |
2. w`y, tiLv, Zj m`umKZ `Ztvm`_tjv D`vniYi mrvvth` e`vL`v`vKte |
3. tiLv, tiLusk, iwk Ges tkvY m`umKZ Dccv` mgn hvPvB Kivi Rb` wky`v`x`Kw`K Kvh`vg msthvRb Ki`fZ nte |
4. mgvsh`ij mij tiLv I Drcb`kvY`_tjvi e`vL`v`wP`fI mrvvth` `vKte |
5. ev`ut`f` I tkvY`f` w`f`f`Ri e`vL`v` Ges eM`AvqZ, i`m I mgvsh`i K wPv`ZKiY w`l`q`_tjv Kvh`vgw`f`EK (activity based) n`fZ nte |
6. Abkxj bx`vKte |

mBsg Aa`vq : e`envi K R`vgnvZ

1. tiLusk cwi gvtci Rb` n`fZ-Kj`fg kvR Kivi Dc`thvMx tkvYKvh`vtgi D`f`L`v`vKfZ nte |
2. tiLusk m`umKZ A`vb, tkvY m`umKZ A`vb`_tjv wP`fI mrvvth` mnR`f`te Dc`vcb Ki`fZ nte |
3. w`Lbdj AR` Dc`thvMx Abkxj bx`vKte |

Aóg Aa`vq : Z` I DcvE`

1. Z` I Dcv`Ei D`vniYi gva`fg e`vL`v`vKte |
2. Aw`b`f`Dcv`Ei Mo, ga`K I c`p`i`K w`y`f`qi eY`v Ges G mspv`sf`D`vniY`vKte |
3. w`v`f`b`Dcv`E`_t`_t`K w`k`f`v`te tiLw`P`f` A`vb Kiv hvq Zvi eY`v D`vniY`vKte |
4. Abkxj bx`vKte |

8. Կյանքի զրկման մեթոդներ

c0g Aa'vq : gj` -Agj` msL'v (15 vci qW)

wklbdj	velqe'	wklb-tklvfbv vbt` Rbv	gj`vqb vbt` Rbv
<p>ey`eEiq</p> <ol style="list-style-type: none"> 1. gj` I Agj` msL'v kbv³ KitZ cvi te 2. msL'v i Lvq gj` I Agj` msL'vi Ae'vb t` LtZ cvi te 3. msL'vi eMq eMqj e'vL'v KitZ cvi te 4. Drcv`K I fVM c0pqi gva'tg eMqj vbyq KitZ cvi te 5. msL'vi eMqj cxwZ,tjv c0qM Kti ev'e Rietbi mgn'vi mgravb KitZ cvi te 	<ul style="list-style-type: none"> • gj`-Agj` msL'v • eMqj i avi Yv • weifbacKvi msL'vi eMqj vbyq • eMqj i e'enwi K c0qM Kti mgn'v mgravb 	<ul style="list-style-type: none"> • wkyK KtqKW msL'v tevWqj tL gj` I Agj` msL'vi eYbv Kiteb Ges wkyv_# i weifbamsL'v wj LtZ w'tq gj` I Agj` msL'v kbv³ KitZ ej teb • wkytKi vbt` #k wkyv_PtevtWmsL'v i Lv A/b Kite Ges weifbaqj` I Agj` msL'vi Ae'vb msL'v i Lvq tKv_vq nte Zv vbt` R Kite • wkyK D'vni tYi mrvth` msL'vi eMq eMqj e'vL'v Kiteb Ges msL'vi eMqj vbyq Drcv`K I fVM c0pqi eYbv Kiteb wkyv_# v weifbamsL'vi eMqj tei Kite c0qvRtb wkyK mrvqZv Kiteb • wkytKi vbt` Rbvq wkyv_xeMqj i cxwZ,tjv c0qM Kti MwywZK mgn'v mgravb Kite 	<ul style="list-style-type: none"> • wkyK wkyv_# i KvR Nji Nji chpeyY Kiteb • tgmLK c0kEti i gva'tg gj`vqb Kiteb • tk0Yi KvRi mrvth` gj`vqb Kiteb • wkyv_# i tevWqWtK mgn'v mgravb KitZ w'tq gj`vqb Kiteb • tk0Y Awfyvi mrvth` gj`vqb Kiteb

ZZxq Aa'vq : cwi gvc (10 ucwi qW)

wKLbdj	weI qe'	wKLb-ikLvtbv wbt' Rbv	gj'vqb wbt' Rbv
<p>epxeEixq</p> <p>1. ^N^cwi gvtci AvStm=úK^e'vL'v KiZ cvi te Ges G mspvšI mgm'v mgvab KiZ cvi te </p> <p>2. IRb I Zij c'vt_P AvqZb cwi gvc wKfvt Kiv nq Zv e'vL'v KiZ cvi te Ges G m=úK^Z mgm'v mgvab KiZ cvi te </p>	<ul style="list-style-type: none"> • ^N^cwi gvc • IRb cwi gvc I Zij c'vt_P AvqZb cwi gvtci GKkviej • IRb I Zij c'vt_P AvqZb cwi gvtci GKK e'envi mspvšI mgm'v 	<ul style="list-style-type: none"> • wkyK `B cxwZi cwi gvcK t'j mieivn Kiteb wkyv_xfv weifbæ cwi gvtci wZbuU iwK ev KwV ev wLZv wbtq Dfq cKvi t' dj i mrvth' cwi gvc Kite Gfvt wkyv_xfv cwi gvcK `BwI AvStm=úR wbyq Kite wkyK c'hvR' tytI mthwMZv Kiteb • wkyK DcKiYi mrvth' IRb cwi gvc I Zij c'vt_P AvqZbi cwi gvc e'vL'v Kiteb Ges wkyv_xfv i cwi gvtci GKK_tjvi gta' m=úK^QK AvKvti wj tL c'k' KiZ ej teb • wkyv_xfv `j MZfvte Zvt' i teA, tUvej, `i Rv, Rvbj v BZ'w' i ^N^ I c'vt' dj i mrvth' t'gtc tytI dj wbyq Kite 	<ul style="list-style-type: none"> • wkyv_xfv i tevtW^ cwi gvtci GKK_tjvi gta' m=úK^QK AvKvti wj tLZ w'tq gj'vqb Kiteb • c'kvE'ti i mrvth' wkyv_xfv i KivR gj'vqb Kiteb
<p>g'tvtc'wK</p> <p>3. weifbæ' j e'envi Kti AvqZvKvi I eMfKvi tytI ^N^ c' c'w' cwi gvc Kti tytI dj wbyq KiZ cvi te </p> <p>4. IRb cwi gvtci weifbæ cwi gvcK e'envi Kti cwi gvc KiZ cvi te </p> <p>5. Zij c'vt_P AvqZb cwi gvtci weifbæ cwi gvcK e'envi Kti cwi gvc KiZ cvi te </p> <p>6. ^bw`b Rxe'tb AvbgwmbK cwi gvc KiZ cvi te </p>	<ul style="list-style-type: none"> • AvqZvKvi I eMfKvi tytI tytI dj cwi gvc 	<ul style="list-style-type: none"> • wkyv_xfv `j xqfvte weifbæ cwi gvtci mrvth' Zij c'vt_P IRb I AvqZb wbyq Kite • wkyK cwi gvc mspvšI Ab'xj bxi mgm'v mgvabt'bi Rb' wkyv_xfv i ej teb Ges c'qvRbxq mrvZv t' teb • e'envi Kfvte wkyv_xfv IRb I Zij c'vt_P AvqZb cwi gvc Abgyb Kite Ges cwi gvtci mrvth' t'gtc Zv hvPvB Kite 	<ul style="list-style-type: none"> • tk'vi KivR I tk'v Avf'vvi mrvth' gj'vqb Kiteb • wkyv_xfv i t'K nvtZ Kj t'g teA, tUvej, `i Rv, Rvbj v cwi gvc KiZ w'tq ch'ey'tYi gva'tg gj'vqb Kiteb • nvtZ Kj t'g Zij c'vt_P IRb I AvqZb cwi gvc KiZ w'tq ch'ey'tYi gva'tg gj'vqb Kiteb

PZL_@Aa`vq : exRMmYZxq iwiki ,Y I fVM (10 ucui qW)

wklbdj	welqe'	wklb-iklvbv ibt`Rbv	gj`vqb ibt`Rbv
<p>exRMmYZxq</p> <p>1. exRMmYZxq iwiki ,Y I fVM KiZ cri te </p> <p>2. eÜbx e`enrtii gra`tg exRMmYZxq iwiki thvM, wetqvM, ,Y I fVM mspvšl`bw`b Rretbi mgm`vi mgravb KiZ cri te </p> <p>AvteMxq</p> <p>3. exRMmYZxq mgm`v mgravtb AvMöx nte </p>	<ul style="list-style-type: none"> • exRMmYZxq iwiki ,Y I fVM • eÜbx e`enrtii gra`tg thvM, wetqvM, ,Y I fVM mspvšl mgm`v 	<ul style="list-style-type: none"> • wkyK D`vni`Yi mrvn`th` exRMmYZxq iwiki ,Y I fVM tertW`Kti t`Lvteb wkyv`šiv Zv Abkxj b Ki te • wkyv`šiv exRMmYZxq iwiki thvM, wetqvM, ,Y I fVM eÜbxi gra`tg mij xKiY Kti mgm`vi mgravb Ki te c`qvr`tb wkyK mrvqZv Ki te 	<ul style="list-style-type: none"> • tköyi KvR I tköy Avfyvi mrvn`th` gj`vqb Ki te • tgšLK c`k`Eti i gra`tg gj`vqb Ki te

Ընթացիկ : Երկրորդ միջին դաս (12 շաբաթ)

Կարգ	Թեմա	Կարգավիճակի Կարգ	Գլխավոր Կարգ
<p>Երկրորդ</p> <ol style="list-style-type: none"> 1. Երկրորդ և երրորդ աստիճանի բազմանդամների արտադրյալի և քառակուսիների քայքայումը 2. Երկրորդ աստիճանի բազմանդամների և երրորդ աստիճանի բազմանդամների արտադրյալի քայքայումը 3. Երկրորդ աստիճանի բազմանդամների և երրորդ աստիճանի բազմանդամների արտադրյալի քայքայումը 4. Երկրորդ աստիճանի բազմանդամների և երրորդ աստիճանի բազմանդամների արտադրյալի քայքայումը 5. Երկրորդ աստիճանի բազմանդամների և երրորդ աստիճանի բազմանդամների արտադրյալի քայքայումը 	<p>Երկրորդ և երրորդ աստիճանի բազմանդամներ</p> <ul style="list-style-type: none"> ○ $(a + b)^2 = a^2 + 2ab + b^2$ ○ $(a - b)^2 = a^2 - 2ab + b^2$ ○ $a^2 - b^2 = (a+b)(a-b)$ ○ $(x + a)(x + b) = x^2 + (a + b)x + ab$ <p>Երրորդ աստիճանի բազմանդամներ</p> <ul style="list-style-type: none"> ○ $a^2 + b^2 = (a + b)^2 - 2ab$ ○ $a^2 + b^2 = (a - b)^2 + 2ab$ ○ $(a + b)^2 = (a - b)^2 + 4ab$ ○ $(a - b)^2 = (a + b)^2 - 4ab$ ○ $(a + b)^2 + (a - b)^2 = 2(a^2 + b^2)$ ○ $(a + b)^2 - (a - b)^2 = 4ab$ <ul style="list-style-type: none"> • Երկրորդ աստիճանի բազմանդամների և երրորդ աստիճանի բազմանդամների արտադրյալի քայքայումը • Երրորդ աստիճանի բազմանդամների և երրորդ աստիճանի բազմանդամների արտադրյալի քայքայումը • Երրորդ աստիճանի բազմանդամների և երրորդ աստիճանի բազմանդամների արտադրյալի քայքայումը 	<ul style="list-style-type: none"> • Երկրորդ աստիճանի բազմանդամների և երրորդ աստիճանի բազմանդամների արտադրյալի քայքայումը • Երկրորդ աստիճանի բազմանդամների և երրորդ աստիճանի բազմանդամների արտադրյալի քայքայումը • Երրորդ աստիճանի բազմանդամների և երրորդ աստիճանի բազմանդամների արտադրյալի քայքայումը • Երրորդ աստիճանի բազմանդամների և երրորդ աստիճանի բազմանդամների արտադրյալի քայքայումը • Երրորդ աստիճանի բազմանդամների և երրորդ աստիճանի բազմանդամների արտադրյալի քայքայումը 	<ul style="list-style-type: none"> • Երրորդ աստիճանի բազմանդամների և երրորդ աստիճանի բազմանդամների արտադրյալի քայքայումը • Երրորդ աստիճանի բազմանդամների և երրորդ աստիճանի բազմանդամների արտադրյալի քայքայումը • Երրորդ աստիճանի բազմանդամների և երրորդ աստիճանի բազմանդամների արտադրյալի քայքայումը • Երրորդ աստիճանի բազմանդամների և երրորդ աստիճանի բազմանդամների արտադրյալի քայքայումը • Երրորդ աստիճանի բազմանդամների և երրորդ աստիճանի բազմանդամների արտադրյալի քայքայումը

I ô Aa'vq : exRMWZxq fMusK (8 ucvi qW)

ukLbdj	velqe'	ukLb-ikLvfbv vbt`Rbv	gj`vqb vbt`Rbv
<p>eyxeE'xq</p> <ol style="list-style-type: none"> 1. exRMWZxq fMusK Kx Zv e'vL'v KitZ cvi te 2. exRMWZxq fMusK j NkiY I mvariY ni wekó KitZ cvi te 3. exRMWZxq fMuski thvM, weqvm Ges mij KitZ cvi te 	<ul style="list-style-type: none"> • fMuski aviYv I fMuski j NkiY • AbaqizbuJ fMuskiK mvariY ni wekó KiY • fMuski thvM, weqvm I mij xkiY 	<ul style="list-style-type: none"> • ukjK cOkvEti i gra'ig fMuski aviYv hvPvB Kti exRMWZxq fMuski eYv t`teb • ukjK D`vni'Yi mvrth' exRMWZxq fMuski thvM I weqvm Kiteb ukjv_@v cv`cy'K i Abkxj bxi mgm'v mgvavb Kiteb 	<ul style="list-style-type: none"> • ukjv_x' i textW'WtK mgm'v mgvavb KitZ w`tq gj`vqb Kiteb • tk'Yi KvR I tk'Y Avf'Yvi mvrth' gj`vqb Kiteb

mβg Aa`vq : mij mgxKiY (10 ucni qW)

wKLbdj	welqe`	wKLb-ʃkLvʃbv wbt` Rbv	gj`vqb wbt` Rbv
<p>epxeE`xq</p> <ol style="list-style-type: none"> 1. mgxKiʃYi c`yvsʃi wewa, eRʃ wewa, Avo_Yb wewa, cʃZmvg` wewa e`vL`v KiʃZ cviʃe 2. wewamgn cʃqM Kʃi mgxKiʃYi mgvavb KiʃZ cviʃe 3. mij mgxKiY MVb I mgvavb KiʃZ cviʃe 4. tj LwPʃ Kx Zv e`vL`v KiʃZ cviʃe <p>gʃbtvcwKR</p> <ol style="list-style-type: none"> 5. tj LwPʃʃ A¶ I mʃeavRbK GKK wbtq we`yvcZb KiʃZ cviʃe 6. tj LwPʃʃi mrvvʃh` mgxKiʃYi mgvavb KiʃZ cviʃe 	<ul style="list-style-type: none"> • mij mgxKiY <ul style="list-style-type: none"> o mij mgxKiʃYi aviYv o tj LwPʃ A¼b o mij mgxKiY MVb, mgvavb (cʃZmvg` wewa, c`yvsʃi wewa, ʃhvʃMi I ʃYi eRʃ wewa e`envi Kʃi) Ges Zv tj LwPʃʃ cʃ kʃ 	<ul style="list-style-type: none"> • wkyK D`vniʃYi mrvvʃh` mgxKiY mgvavʃbi wewamgn e`vL`v Kiʃeb wkyv_ʃv wewamgn `j xqfʃte wj ʃL Dc`vcb Kiʃe • wkyv_ʃv mgxKiʃYi wewamgn e`envi Kʃi mij mgxKiY MVb I mgvavb Kʃi wkyKʃK ʃ`Lvʃe • ʃeʃW`QK ʃKʃU Aʃy wPwYZ Kʃi tj L A¼ʃbi cʃµqv e`vL`v Kiʃeb • wkyv_ʃv mʃeavRbK GKK wbtq mij mgxKiʃYi tj LwPʃ A¼b Kiʃe cʃqRʃb wkyK mrvqZv Kiʃeb 	<ul style="list-style-type: none"> • wbaʃi Z gvb`ʃUi mrvvʃh` `j MZ KvR gj`vqb Kiʃeb • wbaʃi Z gvb`ʃUi gvaʃg ʃkʃYi KvR I ewoi KvR gj`vqb Kiʃeb • wkyv_ʃv QKKwMR e`envi Kʃi mwKfʃte mgn`v mgvavb KiʃZ cviʃQ wKbv-Zv hvPvB Kiʃeb

Aóg Aa`vq : mǵvšl'ij mij ti Lv (15 vci qW)

wKlbđj	velqe`	wKlb-řkLvřbv wbt` Rbv	gj`vqb wbt` Rbv
<p>epxeřxq</p> <p>1. mǵvšl'ij mij ti Lv I tQ`K řiv Drcbe řKřřYi `ewkO` e`vL`v KiřZ cviře </p> <p>2. `řwU mij ti Lv mǵvšl'ij nI qvi kZ`eYřv KiřZ cviře </p> <p>3. `řwU mij ti Lv mǵvšl'ij nI qvi kZ`cřvY KiřZ cviře </p>	<p>mǵvšl'ij mij ti Lv</p> <ul style="list-style-type: none"> • mǵvšl'ij mij ti Lv, GKvřli řKřřY, Abje řKřřY, tQ`řKi GKB cvřk, Ařli`řKřřY • `řwU mij ti LvřK Aci GKwU mij ti Lv tQ` Kiřj hw GKvřli řKřřY, řjv ci`ui mǵvř nq A_ev Abje řKřřY, řjv mǵvř nq A_ev tQ`řKi GKB cvřki Ařli`řKřřY `řwUi mǵvř `ř mǵřKřřYi mǵvř nq Zře H ti Lv `řwU mǵvřl'ij -Zv hvřvB Ges Gi weciřZ MwřvřZK evK`wU hvřvB I cřvřY Kiře 	<ul style="list-style-type: none"> • wkyK mǵvšl'ij mij ti Lv I tQ`řKi wřT řevřw® GřK wkyv_ř`i GKvřli řKřřY I Abjřc řKřřYi aviřv `úó Kiřeb • wkyv_řiv ti Lv I řKřřY m`úwKř cO`E Z`_ř_řK nřřZ Kj řg řgřc ti Lv, řjv mǵvřl'ij wKbv hvřvB I cřvřY Kiře 	<ul style="list-style-type: none"> • wkyv_řiv ti Lv I řKřřY m`úwKř cO`E Z`_ř_řK nřřZ Kj řg cwiřvřc Kivi mǵq wkyK gj`vqb Kiřeb

beg Aa`vq : wî fR (20 vcvî qW)

wKlbdj	vel qe`	wKlb-îkLvîbv wî` Rbv	gj`vqb wî` Rbv
<p>epxexq</p> <ol style="list-style-type: none"> wî fîRi Ašt` I eint` tKvY eYv KiZ cvi wî fîRi tgšij K Dccv` , tjv cgvY KiZ cvi wî fîRi evû I tKvYi cvi` úwi K m`úK`eni Kti RxebwîEK mgm`vi mgvavb KiZ cvi <p>gîbtvcîkR</p> <ol style="list-style-type: none"> wefbâkZmîtcjy wî fR AvkîZ cvi wî fR tyîi fvg I D`PZv tgc tyîdj cwi gvc KiZ cvi 	<ul style="list-style-type: none"> wî fîRi Ašt` I eint` tKvYi avi Yv <p>wî fR mspvšî Dccv` I cgvY</p> <ul style="list-style-type: none"> wî fîRi wzb tKvYi mgw` ß mgîKvYi mgvb wî fîRi th tKvîbv` Bw evûi mgw` Gi ZZxq evû Atcÿv epÊi wî fîRi GKw evû Aci GKw evû Atcÿv epÊi ntj , epÊi evûi wecixZ tKvY jî Zi evûi wecixZ tKvY Atcÿv epÊi nte <p>wî fR mspvšî m`úv`</p> <ul style="list-style-type: none"> wî fîRi wzbw evû t` I qv AvtQ, wî fRw AvkîZ nte wî fîRi `Bw evû I Gî i Ašîf` tKvY t` I qv AvtQ, wî fRw AvkîZ nte tKvîbv wî fîRi GKw evû I Gi msj Mæ Bw tKvY t` I qv AvtQ, wî fRw AvkîZ nte wî fîRi `Bw tKvY I Gî i GKw i wecixZ evû t` I qv AvtQ, wî fRw AvkîZ nte tKvîbv wî fîRi `Bw evû Ges Gî i GKw i wecixZ tKvY t` I qv AvtQ, wî fRw AvkîZ nte mgîKvYx wî fîRi AwZfR I Aci GKw evû t` I qv AvtQ, wî fRw AvkîZ nte tKvîbv wî fîRi `Bw evû Ges Gî i GKw i wecixZ tKvY t` I qv AvtQ, wî fRw AvkîZ nte 	<ul style="list-style-type: none"> wkÿv_šv textWwî fîRi GKw evû ewaz Kti wî fîRi Ašt` I eint` tKvY wPvZ Kite wkÿK c`qvRbxq mnvqZv t` teb wkÿv_šv `j xqfite wî fR A¼b Kti evû I tKvYi cwi gvc Kite Ges wî fR mspvšî Dccv` , tjv hvPvB Kite G tyîi wkÿK c`qvRbxq mnvqZv t` teb wkÿv_šv wî fR mspvšî Dccv` , tjv cgvY Kite wkÿK wî` Rbv c`vb Kti wkÿv_šv i textWwîK wefbâR`wgvZK wPî A¼b Kiteb Gfite KîqKRb wkÿv_šv i w`tq textWwîKivbi ci c`Z`K wkÿv_šv LvZvq A¼b Kite wkÿK c`qvRbxq mnîhwMzv Kiteb wkÿv_šv wî fR tyîi fvg I D`PZvi cwi gvc Kti wî fR tyîwî tyîdj tei Kite Ges Gi mnvîth` PZfR tyîi tyîdj cwi gvc Kite 	<ul style="list-style-type: none"> wkÿK chÿÿY I c`kwÊti i gva`tg gj`vqb Kiteb textWwîKwîK wkÿv_šv i tWîK Dccv` , tjv cgvY Kivi gva`tg hvPvB Kiteb wkÿv_šv i LvZvq wefbâe ai tbi A¼b KiZ w`tq hvPvB Kiteb nvZ Kj tg wefbâwî fR tyîi fvg I D`PZv cwi gvc KiZ w`tq chÿÿÿYi gva`tg gj`vqb Kiteb tkÿYi KvR I tkÿY Awfÿvi mnvîth` gj`vqb Kiteb

kg Aa`vq: m`kZv I meŋgZv (15 wci qW)

wLbdj	vel qe`	wLb-tkLv`bv wbt`Rbv	gj`vqb wbt`Rbv
<p>epxeE`xq</p> <ol style="list-style-type: none"> 1. newfbaeR`wgvZK AvKvi I AvKvZ ntZ meŋg Ges m`k AvKvi I AvKvZ wPyZ KiZ cvite 2. meŋg I m`kZvi gta` cv_R` KiZ cvite 3. wov`e`enkto`i Avtj vK wifR I PZfRi m`kZv evLv KiZ cvite 4. wov`e`enkto`i wfiEtZ wifRi meŋgZv cgvY KiZ cvite 5. meŋgZv I m`kZvi `enkto`i wfiEtZ mnR MwYvZK I ev`e mgm`vi mgravb KiZ cvite 	<p>meŋgZv I m`kZv</p> <ul style="list-style-type: none"> • meŋgZv I m`kZvi aviYv (newfbae`thgb c`p, c`Zwea; Ovqv BZ`w` i mnvth`) • m`kZv • wifR I PZfRi tytI m`kZv • wifR I PZfRi tytI m`kZvi KwZcq Dccv` hvPvBKiy: <ul style="list-style-type: none"> ◦ `Bw wifRi Abjfc evuMjv mgrvpcwZK ntj wifR `Bw m`k nte ◦ `Bw wifRi GKwI tKvY,tjv hw` avivewvKfite AciwI tKvY,tjvi mgrv nq Zte wifR `Bw m`kKvYx nte ◦ `Bw PZfRi Abjfc evuMjv mgrvpcwZK ntj PZfR `Bw m`k nte ◦ `Bw PZfRi GKwI tKvY,tjv hw` avivewvKfite AciwI tKvY,tjvi mgrv nq Zte PZfR `Bw m`kKvYx nte • wifRi meŋgZv Dccv` I cgvY <ul style="list-style-type: none"> ◦ hw` `Bw wifRi GKwI `B evu AciwI `B evu mgrv nq Ges evu `BwI Ašif` tKvY `Bw ci`úú mgrv nq, Zte wifR `Bw meŋg ◦ hw` tKv`bv wifRi `Bw tKvY I GKwI evu h_vKtg Aci GKwI wifRi `Bw tKvY I Abjfc evu mgrv nq Zte wifR `Bw meŋg ◦ hw` tKv`bv wifRi wZb evu Aci GKwI wifRi wZb evu mgrv nq Zte wifR `Bw meŋg ◦ GKwI mgKvYx wifRi AwZfR I GK evu Ab` GKwI mgKvYx wifRi AwZfR I GKevu mgrv ntj wifR `Bw meŋg nte • meŋgZv, m`kZvi `enkto`i wfiEtZ mnR mgm`v 	<ul style="list-style-type: none"> • wkyv`xv eB, LvZv I e- BZ`w` i mnvth` meŋg I m`k AvKvi Ges AvKvZi aviYv jvf Kite GB tytI wkyK c`qvRbxq mnvqZv c`vb Kiteb • wkyv`xv tRovq Avtj vPbv Kti meŋgZv I m`kZvi cv_R` wj Lte • wkyv`xv wifR I PZfR Awb Kite Ges `jxqfite wifR I PZfRi evu I tKvY cwi gvc Kti m`kZvi Dccv` ,tjv hvPvB Kite • wkyK newfbae`i wifR AwZ GKwI KgeI wkyv`x` i mieivn Kiteb KgeI i wbt`Rbv Abjvfi wkyv`xv evu I tKvY,tjv cwi gvc Kti wifRi meŋgZv hvPvB Kite • wkyv`xv wkyv`Ki mnthwMZvq meŋgZvi Dccv` ,tjv cgvY Kite Dccv` ,tjv c`qvM Kti mgm`v mgravb Kite c`qvRtb wkyK mnvqZv Kiteb 	<ul style="list-style-type: none"> • tk`Yi KvR w`tq wov`e` gvb`te wfiEtZ gj`vqb Kiteb • ev`ewfivEK mgm`v mgravb KiZ w`tq gj`vqb Kiteb • emoi KvR w`tq wov`e` gvb`te wfiEtZ gj`vqb Kiteb • tevW`ch`q`m`g wkyv`x` i tWtK ev GKKfite LvZvq Dccv` ,tjv cgvY KiZ w`tq hvPvB Kiteb • tk`Y Awfyvi mnvth` gj`vqb Kiteb

GKv`k Aa`vq: Z_ I DcvE (10 vcv qW)

wLbdj	velqe`	wLb-tkLvfbv vbt`Rbv	gj`vqb vbt`Rbv
<p>ep`eE`q</p> <ol style="list-style-type: none"> 1. MYmsL`v mviwY Kx Zv e`vL`v KiZ cvi te 2. tkWY e`earfbi gva`tg Awb`I DcvE web`I AvKvfi cKvk KiZ cvi te 3. AwZ AvqZtj L ntZ DcvE m`utK`e`vL`v KiZ cvi te 4. AvqZtj L ntZ cPi K wYq KiZ cvi te <p>gfbvcukR</p> <ol style="list-style-type: none"> 5. AvqZtj L A`b KiZ cvi te 	<ul style="list-style-type: none"> • MYmsL`v mviwY • tkWY e`earfbi gva`tg MYmsL`v mviwY MVb • Z_ I DcvEi AvqZtj L • AvqZtj L ntZ cPi K wYq 	<ul style="list-style-type: none"> • wKQzmsL`K wkyv`i MvYtZ cOB b`f vbtq wkyK MYmsL`v mviwY I tkWY e`earb Gi e`vL`v t`teb Ges wkyv`i cOB DcvE t`tK wv`e tkWY e`earfbi gva`tg MYmsL`v mviwY `Zwi KiZ ej teb • wkyK MYmsL`v mviwY t`tK AvqZtj L A`tbi aviYv t`teb Ges wkyv`i AvqZtj L A`b KiZ ej teb cOqvRtb wkyK mnvqZv Ki teb • wkyv`i e`enwi Kfite Awb`I DcvE`K web`I AvKvfi cKvk Kti AvqZtj L ntZ cPi K wYq Ki te Ges wkyK cOqvRtb mnvqZv Ki teb 	<ul style="list-style-type: none"> • tgSLK cOkwEti i gva`tg gj`vqb Ki teb • wbaWi Z gvb`tUi mnvth` j MZ KvR gj`vqb Ki teb • tkWi KvR I tkWY Awf`yvi mnvth` gj`vqb Ki teb • wbaWi Z KvRi gvb`tUi mnvth` gj`vqb Ki teb

10. mBq tkWi MwZ eBtqi Rb` tj LK vbt` Rbv

cQg Aa`vq : gj`-Agj` msL`v

1. gj` I Agj` msL`vi e`vL`v _vKte|
2. msL`vi eMqj` wBYqj` Drcv`K I fVM cQqv`i e`vL`v _vKte|
3. eMqj` wBYqj` c`wZ cQqv`Mi Rb` MwYwZK mgm`vi D`vniY _vKte|
4. eMqj` wBYqj` c`wZ cQqv`Mi Rb` chwB Abkxj` bx _vKte|
5. wevfbæi`tbi eK, i`vOb UvBj`m, KW`Ayi msL`v, msL`vtiLv, R`wguZK wP`T BZ`w`i gra`tg c`vUvtp` avi Yv e`vL`v _vKte|
6. thvM, wevqM, _Y I fVM cQqv`i gra`tg msiL`K c`vUvtp` avi Yv I MVb e`vL`v mn D`vniY I Abkxj` bx _vKte|
7. msL`vi aviv, msL`vtiLv, `tctj`L, R`wguZK wP`T, WvqMqg BZ`w`i gra`tg R`wguZK c`vUvtp` avi Yv I MVb e`vL`v mn D`vniY I Abkxj` bx _vKte|

wZxq Aa`vq : mgvbcvZ I jvf-`jwZ

1. e`uiwkk I avivewk AbcvZ
2. D`vni`Yi mrvv`th` fMsk I kZKivi ga`Kvi m`u`tkP` cpi`vtj` vPbv msthvRb Ki`tZ nte|
3. wuqK mgvbcv`Zi e`vL`v Ges mgvbcvZ I wuqK mgvbcv`Zi MwYwZK wbgvewj` i eY`v _vKte|
4. cQZ`wnK Rxe`tb e`enZ D`vni`Yi mrvv`th` jvf`jwZi e`vL`v |
5. jvf`jwZ, Kwqkb, gy`weibgq, f`vU I Ki wBYqj` D`vni`Yi mrvv`th` e`vL`v w`tZ nte|
6. Hwkk I AbcvZ e`envi Kti`mgq I KvR, bj I tP`sev`Pv, mgq I `tZi Ges tbsKv I t`tZ we`lqK MwYwZK mgm`vi D`vniY w`tZ nte|
7. Abkxj` bx _vKte|

ZZxq Aa`vq : cwigvc

1. D`vni`Yi mrvv`th` `N`cwigv`ci eY`v _vKte|
2. D`vni`Yi mrvv`th` I Rb I Zij`c`vt`P` AvqZb cwigvc e`vL`v _vKte|
3. I Rb cwigvc I Zij`c`vt`P` AvqZb cwigv`ci GK`tki PvU`vKte|
4. wky`v`xPv thb nrtZ Kj`tg ev`b DcKiY cwigvc Kti` `bw`b Rxe`tb AvbgmbK cwigvc Ki`tZ Af`TInq-G j`ty` wky`v`xPw`K Kvh`qg _vKte|
5. cwigv`ci e`envi m`u`wKZ mgm`v msej`Z Abkxj` bx _vKte|

PZL Aa`vq : exRMWZxq ivki _Y I fVM

1. exRMWZxq ivki _Y I fVM c>wZi e`vL`vnm D`vniY I Abkxj bx _vKte |
2. exRMWZxq ivki thvM, we tqvM, _Y I fVM msµvšl`b` b Rxe tbi mgm`v, mgm`vi mgravb I Abkxj bx _vKte |

cÂg Aa`vq : exRMWZxq mĤvej I cĖqM

1. eM`byŋq exRMWZxq mĤ I Abym>všl`i e`vL`v _vKte (m>te` tÿtĤ R`wgwZK e`vL`v _vKte) |
2. exRMWZxq mĤ I Abym>všl`i cĖqM KĤi ivki gvb wbyŋqi e`vL`vnm D`vniY I Abkxj bx _vKte |
3. mĤĤi mrvvth` Drcv` tK we tki Y wbyŋqi e`vL`vnm D`vniY I Abkxj bx _vKte |
4. _YbxqK I _wYZĤKi D`vniYmn e`vL`v _vKte |
5. AbpY`ZbiU exRMWZxq ivki mvsil`Kmm M.mv. _ I j .mv. _ wbyŋ D`vniY I Abkxj bx _vKte |

Iô Aa`vq : exRMWZxq fMusk

1. exRMWZxq fMusk i aviYv e`vL`vnm D`vniY _vKte (m>te` tÿtĤ wPĤ I Qwei gra`tg) |
2. AbaY`ZbiU fMusk tK mvariY ni weikóKi tÿi wq tgi eY`vnm D`vniY I Abkxj bx _vKte |
3. fMusk i thvM, we tqvM I mij xKi tÿi wq tgi e`vL`vnm D`vniY I Abkxj bx _vKte |

mBq Aa`vq : mij mgxKiY

1. mgxKi tÿi weiamgĤni (cÿvšli, eRĖ, Avo _Yb I cĖZmg) e`vL`vnm D`vniY _vKte |
2. weiamgĤ cĖqM KĤi mij mgxKiY mgrav tbi tKškj eY`vnm D`vniY I Abkxj bx _vKte |
3. mij mgxKi tÿi MVb cĖµqv e`vL`vnm D`vniY _vKte |
4. mij mgxKi tÿi mgravb tj LwPĤ cĖ kĤbi e`vL`vnm D`vniY I Abkxj bx _vKte |
5. mgxKi tÿi weiamgĤni (cÿvšli, eRĖ, Avo _Yb I cĖZmg) e`vL`vnm D`vniY _vKte |
6. weiamgĤ cĖqM KĤi mij mgxKiY mgrav tbi tKškj eY`vnm D`vniY I Abkxj bx _vKte |
7. mij mgxKi tÿi MVb cĖµqv e`vL`vnm D`vniY _vKte |
8. mij mgxKi tÿi mgravb tj LwPĤ cĖ kĤbi e`vL`vnm D`vniY I Abkxj bx _vKte |

Aóg Aa`vq : mgvšl`ij mij ĤiLv

1. cwi cwkĤ D`vniY I wPĤĤi mrvvth` mgvšl`ij mij ĤiLvi aviYv e`vL`v Ki tZ nte |
2. `Bw mij ĤiLv mgvšl`ij nI qvi kZ` cĖY _vKte |
3. mgvšl`ij mij ĤiLv I tQ`K Ōiv DrcbĤK tÿi `enk tó`i e`vL`v _vKte |

beg Aa`vq : wî fR

1. wPîi gva`tg wî fRi Ašt` I eint` tKvY eYv Ki`Z nte|
2. wî fR msµvš`tgšj K Dccv` , t`j vi cõvY hvPvBKiy mnR I mvej xj cõvY _vKte|
3. wî fRi evû I tKvY m`uKZ mgm`v mgravtbi mnR I AvKI`xq D`vni Y _vKte|
4. cÔË Zt`i wfvËZ wî fR A½tbi mnR c`wZ Avtj vPbv _vKte|
5. wî fRi fwg I D`PZvi cwi gvc Øviv wî fRi t`yÎdj wYq`i c`wZ D`vni t`yi mvrth` Dc`vcb Ki`Z nte Ges G msµvš`m gm`v msewj Z Abkxj bx _vKte|

`kg Aa`vq : m`kZv I meñgZv

1. eB, LvZv, e· BZ`w`i mvrth` meñg I m`kZvi aviYv e`vL`v Ki`Z nte Ges meñg I m`kZvi cv`R` wPvY Z Ki`Z nte|
2. wv`Ø`eñkto`i wfvËZ wî fR I PZfRi m`kZvi e`vL`v _vKte|
3. wv`Ø`eñkto`i wfvËZ wî fRi meñgZvi cõvY _vKte|
4. wPÎ I D`vni Y Øviv meñgZv I m`kZv msµvš`m gm`vi mgravb Ges Abkxj bx _vKte|

GKv`k Aa`vq : Z` I DcvË

1. MYmsL`v mviwY I tKvY e`ear`bi D`vni Ymn eYv w`tZ nte|
2. MYmsL`v mviwY `Zwi i e`vL`v w`tZ nte|
3. MYmsL`v mviwY `Zwi , AvqZtj L A½b Ges AvqZtj L ntZ cP`i K wYq` msµvš`m gm`vi D`vni Y I Abkxj bx w`tZ nte|

10. εκτύπωση ΟΚ

Αόγ tkÖ

cŭg Aa'vq: c'vUvb© (10 ucni qM)

wKlbdj	vel qe'	wKlb-tklv'bv vbt' Rbv	gj'vqb vbt' Rbv
<p>ep'eExq</p> <ol style="list-style-type: none"> c'vUvb© avi Yv e'vL'v Ki tZ cvi te wefbœaitbi c'vUvb© wj LtZ l eYb Ki tZ cvi te Avti wcz kZb'vqx mnR c'vUvb© wj LtZ l eYb Ki tZ cvi te c'vUvb© wv' ŒZg msL'v tei Ki tZ cvi te <p>AvteMxq</p> <ol style="list-style-type: none"> msL'v vbtq tLj vi gva'tg msL'vi cŭZ AvMhx ntq DVte wefbœmsL'wfvEK tLj v 'Zwi tZ m'pó nte 	<ul style="list-style-type: none"> c'vUvb© Gi avi Yv wefbœaitbi c'vUvb© MVb l mgm'v mgvavb <ul style="list-style-type: none"> o cvRj l tMgm (msL'v l Ayi msewj Z) o wefvR'Zv (3 l 4 A'ti msL'v) o R'wgvZK c'vUvb© o %wLK c'vUvb© c'vUvb© K Pj tKi gva'tg exRMwYZxq i wkgvj vq cKvk c'vUvb© wv' ŒZg msL'v tei Kiv 	<ul style="list-style-type: none"> wkÿK D'vniY l wPt' i gva'tg c'vUvb© avi Yv t' teb wkÿv_ŕv msL'v l R'wgvZK wPt' i m'vnt' wefvbœ'vUvb© wj LtZ wkÿv_ŕv cvRj, tMgm, wefvR'Zv BZ'w i gva'tg wefvbœaitbi c'vUvb© 'j xqfvte tcv'vi tccv'ti wj tL Dc'rcb Kite wkÿK cŭqR'tb mnvqZv Kiteb wefbœaitbi c'vUvb© wj tL l wPt' A'ti gva'tg wkÿv_ŕv c'vUvb© m'vnt'K'Zv't' i ce'avi Yv eYb Kite Gi g'ta' tKvb' t'v 'wLK c'vUvb© Zv Dc'rcb Kite wkÿK Avtj vPvvi gva'tg 'wLK c'vUvb© avi Yv 'úo Kiteb wkÿv_ŕv cvRj, tMgm, wefvR'Zv BZ'w i gva'tg 'wLK c'vUvb© 'j xqfvte tcv'vi tccv'ti wj tL Dc'rcb Kite wkÿK wefvbœ msL'wfvEK tLj v 'Zwi tZ DrmwvZ Kiteb Ges cŭqR'tb mnvqZv Kiteb 	<ul style="list-style-type: none"> wkÿK N'ti N'ti ch'eÿ'tYi gva'tg wkÿv_x' i KvR ntZ Zv't' i ce'Avb gj'vqb Kiteb wkÿv_x' i tev'w'w'tK mgm'v mgvavb Ki tZ w'tq gj'vqb Kiteb tk'Yi KvR, emoi Kv'Ri m'vnt' gj'vqb Kiteb cvRj, tMgm Gi cŭZ'thwMZvi gva'tg msL'wfvEK tLj v 'Zwi tZ wkÿv_x' i AvMh gj'vqb Kiteb

ՎՅՋԱԳ ԱԲՎՈՂ: ԳՐԱԾՆ (15 ԱՐՄԱՆՈՒՄ)

ՎԿԼԵԵԵ	ՎԵԼՈՂՆԵՐ	ՎԿԼԵ-ԻՎԼՎԵԾՆ ԵՐՆԵՐՆԵՐ	ԳՅՆՎՈՅ ԵՐՆԵՐՆԵՐ
<p>ԵՐՆԵՐՆԵՐ</p> <p>1. Գրածն Կ՝ ԶՎ ԵՂ ԻՅ ԿՎԵԻԵ </p> <p>2. միՂ Լ ՔՄԵՐՆԵՐ ԳՐԱԾՆԻ ՆՎԻ ԵՎԼՎՆ ԿԻՅ ԿՎԵԻԵ ԳԵՏ Գ ՄՏՄՎՏԻՄԳՄՆԻ ՄԳՐԱՅ ԿԻՅ ԿՎԵԻԵ </p> <p>ԱՎԵԼՈՒՄ</p> <p>3. ԵՎՏԻԿԻ ՆՈՄՎԵ ՎԵԵԻ ԿՎԵՏԻՅ ԱՎՄՈՒՄ ՆԵԻԵ </p>	<ul style="list-style-type: none"> • միՂ ԳՐԱԾՆ Լ ՔՄԵՐՆԵՐ ԳՐԱԾՆ • ԳՐԱԾՆ ՄՏՄՎՏԻՄԳՄՆԻ 	<ul style="list-style-type: none"> • ՎԿՅՎ ԿՅՎՆՔԻ Ի ՄԱՍԻՄ ԱՏԿՄՈՒԿԻ ԳՐԱՂԳ ԵՎՎ-ԿՆԻ Լ ԵՎՏԻԿԻ ՆՈՄՎԵ ՎԵԵԻ ԿՎ ԻՅ ԳՐԱԾՆ Լ ՔՄԵՐՆԵՐ ԳՐԱԾՆԻ ԱՎԻ ԿՎ ԴԿՎԵԿ ԿԻՅԵԻԵ • ՎԿՅՎՆՔԻ ՎԿՅՎԻԿԻ ՄՈՎԶՎԳ ՄԻՂ ԳՐԱԾՆ Լ ՔՄԵՐՆԵՐ ԳՐԱԾՆԻ ՄԻ ՔՎԵՐՆԵՐ ԿՎԵԻԵ • ՎԿՅՎՆՔԻ ՄԻՂ ԳՐԱԾՆ Լ ՔՄԵՐՆԵՐ ԳՐԱԾՆԻ ՄԻ ԵՎՆԻ ԿՎԻ ԵՎԵՐ ԵՐՆԵՐՆԵՐ ԳՐԱԾՆ ՄԱՍԻՄ ԱՏԿՎՆԻ ԿՎԻՅ ԿՎԵԻԵ ԿՎԵՐՆԵՐ ՎԿՅՎ ՄՈՎԶՎԳ ԿԻՅԵԻԵ 	<ul style="list-style-type: none"> • ԵՎՎ-ԿՆԻ Լ ԵՎՏԻԿԻ ՆՈՄՎԵ ՎԵԵԻ ԿՎ ԻՅ ԳՐԱԾՆ Լ ՔՄԵՐՆԵՐ ԳՐԱԾՆԻ ԱՎԻ ԿՎ ԴԿՎԵԿ ԿԻՅԵԻԵ ԳՅՆՎՈՅ ԿՎԻ ԳԳ ԴԳՎԵԿ ԿԻՅԵԻԵ • ԳՐԱԾՆ Լ ՔՄԵՐՆԵՐ ԳՐԱԾՆԻ ՄԻ ՔՎԵՐՆԵՐ ԿՎԻ ԿՎԻ ԳՐԱՂԳ ՎԿՅՎՆՔԻ Ի ԿՎԻՄԿՎԻՄՆՆԵՐ ԿՅՎՆՔԻ ԳՅՆՎՈՅ ԿԻՅԵԻԵ • ՎԵՐՆԵՐ ԳՐԱՂԳ ԵՎԻ ՎԵՐՆԵՐ ԻՎԻ ԿՎՐ ԳՅՆՎՈՅ ԿԻՅԵԻԵ • ԵՎԵՐՆԵՐՆԵՐ ԿՎԻՅ ԿՎԵԻԵ ԿՎԵԻԵ • ԵՎՆԻ ԿՎՐ ԿՎԵԻԵ ԳՅՆՎՈՅ ԿԻՅԵԻԵ

ZZxq Aa`vq : cwi gvc (10 ucni qll)

wklbdj	velqe`	wklb-tklvfbv vbt` Rbv	gj`vqb vbt` Rbv
<p>ey`eExq</p> <p>1. t`kxq, weiluk I AvSRWZK cwi gvc cxwZ e`vL`v Ki tZ cvi te Ges msikw cxwZi mnvrt`h` ``N` tyTdj, I Rb I Zij c`vt`P AvqZb wbyq msewj Z mgm`vi mgvavb Ki tZ cvi te </p> <p>gtbv`cukR</p> <p>2. t`kxq, weiluk I AvSRWZK cxwZtZ ``bw` b Rxe`b cPij Z cwi gvc tKi mnvrt`h` cwi gvc Ki tZ cvi te</p>	<ul style="list-style-type: none"> • cwi gvtci t`kxq, weiluk I AvSRWZK cxwZi m`u`K • t`kxq, weiluk I AvSRWZK cxwZtZ ``N` tyTdj, I Rb I Zij c`vt`P AvqZb wbyq m`u`KZ mgm`v 	<ul style="list-style-type: none"> • wky`v`xv tkwYKty`i weifbæ`' thgb tUvej, teA, t`qvj BZ`w`i ``N` tgtc ckwEti i gra`tg Zv tRtb LvZvq wj Lte wky`K G`tjv t`tK `i`wLK cwi gvtci avi Yv m`y`u`o Kiteb Ges G mspu`S`i mgm`vevj i mgvavb Kiteb • wky`K tkwYKty` (m`e` ntj) wky`v`x`i I Rb cwi gvc Kti Zv`i I Rb tRtb t`bteb G t`tK I Rb cwi gvtci avi Yv t`teb weifbæ`Pv`U`P gra`tg AvStm`u`K`tj vi avi Yv wbtq MmYwZK mgm`v mgvavb mnvqZv Kiteb • wky`K Zij c`vt`P AvqZb cwi gvtci Rb` tkwYKty` weifbæ`AvKwZi e`i mnvrt`h` AvqZb cwi gvtci avi Yv t`teb wky`v`xv wky`tKi mnvqZvq G mspu`S`i MmYwZK mgm`vi mgvavb Kiteb 	<ul style="list-style-type: none"> • wky`v`xv ``N` cwi gvtci mgq wky`K Nti Nti chfejY Kiteb Ges tg`wLK ckwEti i gra`tg gj`vqb Kiteb • ev`b wfiEK mgm`v mgvavb Ki tZ w`tq gj`vqb Kiteb • nv`Z Kj`tg KvR w`tq gj`vqb Kiteb

PZL ©Aa'vq: exRMWZxq mĤvej I cĀqM (12 ucvi qW)

wLbdj	vel qe'	wLb-tkLvĤv vbt`Rbv	gj`vqb vbt`Rbv
<p>exRMWZxq</p> <ol style="list-style-type: none"> 1. exRMWZxq mĤ cĀqM KĤi wĀc`x I wĤc`x i wki eM© wbiſcY, mij xKiY I gvb wYĒ KiĤZ cviĤe 2. exRMWZxq mĤ cĀqM KĤi wĀc`x I wĤc`x i wki Nb wYĒ, mij xKiY I gvb wYĒ KiĤZ cviĤe 3. ga`c` wĤkdĤYi mivvĤh` i wkgvj vi Drcv`K wĤkdĤY KiĤZ cviĤe 4. exRMWZxq i wkgvj vi M.mv. . I j .mv. . wYĒ KiĤZ cviĤe 	<ul style="list-style-type: none"> • mBg tkĀYĤZ cWZ mĤ I AbymxvšĤ cĀqM KĤi eM© gvb wYĒ (wĀc`x/wĤc`x) thgb- <ul style="list-style-type: none"> o $ab = \left(\frac{a+b}{2}\right)^2 - \left(\frac{a-b}{2}\right)^2$ o $(a + b + c)^2 = a^2 + b^2 + c^2 + 2ab + 2bc + 2ca$ • NbdĤj i mĤ I cĀqM <ul style="list-style-type: none"> o $(a + b)^3 = a^3 + 3a^2b + 3ab^2 + b^3 = a^3 + b^3 + 3ab(a + b)$ o $(a - b)^3 = a^3 - 3a^2b + 3ab^2 - b^3 = a^3 - b^3 - 3ab(a - b)$ o $a^3 + b^3 = (a + b)(a^2 - ab + b^2)$ o $a^3 - b^3 = (a - b)(a^2 + ab + b^2)$ • NbdĤj i AbymxvšĤ I cĀqM <ul style="list-style-type: none"> o $a^3 + b^3 = (a + b)^3 - 3ab(a + b)$ o $a^3 - b^3 = (a - b)^3 + 3ab(a - b)$ o $x^2 + px + q$ Ges $ax^2 + bx + c$ AvKvĤi i i wki Drcv`ĤK wĤkdĤY • M.mv. . I j .mv. . wYĒ 	<ul style="list-style-type: none"> • wkyv_Ĥ i mivvZvq wkyK exRMWZxq i wki eM© Nb wYĒqi mĤvej I AbymxvšĤ mĤe` tĤĤ RvqvZK eivLvi gva`g AvĤj vPbv KiĤeb wkyv_Ĥv G mšvšĤ mĤvi mĤvavb tevWĒKiĤeb Abkxj bxi mĤvi mĤvavb wkyv_Ĥv wR wR LvZvq KiĤeb cĀqRĤb wkyK mivvZv KiĤeb • wkyK ga`c` wĤkdĤYi mivvĤh` Drcv`ĤK wĤkdĤY tevWĒKiĤeb wkyv_Ĥ i tevWĒGĤb G aiĤbi mĤvi mĤvavb KiĤeb ejĤeb Ges cĀqRĤb mivvZv KiĤeb • wkyK AbaYĒ c`x exRMWZxq i wki M.mv. . I j .mv. . wYĒqi ceĀvb hvPvB KiĤeb wkyK wĤfĤbi exRMWZxq i wki M.mv. . I j .mv. . wYĒ c×wZ D`vni Ymn eYĀv KiĤeb wkyv_Ĥv `j xqfĤe KĤqKw mĤvi mĤvavb KĤi Ĥ`LvĤe Ges cĀqRĤb wkyK mivvZv KiĤeb 	<ul style="list-style-type: none"> • mĤ AvĤj vPbv mĤq tgšwLK cĀkĤĤi i gva`g wkyK wkyv_Ĥ i ceĀvb hvPvB KiĤeb • wkyv_Ĥ i tevWĒWĤK mĤvi mĤvavb KiĤeb w`Ĥq gj`vqb KiĤeb • ĤRvovq I `j MZ KvR w`Ĥq gj`vqb KiĤeb

Iô Aa`vq : mij mnmgxKiY (10 vcnî qll)

vklbdj	velqe`	vklb-tklvfbv vbt` Rbv	gj`vqb vbt` Rbv
<p>ey`eE`xq</p> <p>1. mgxKiYi cîZ`vcb c×wZ I Acbqb c×wZ e`vL`v KiZ cvite </p> <p>2. `ß Pj K weikó mij mnmgxKiYi mgvavb KiZ cvite </p> <p>3. MwYwZK mgm`vi mij mnmgxKiY MVb Kti mgvavb KiZ cvite </p> <p>gfbv`cukR</p> <p>4. mij mnmgxKiYi mgvavb tj LwPti t`LvZ cvite </p> <p>5. tj LwPti mnmvth` mij mnmgxKiYi mgvavb KiZ cvite </p> <p>AvteMxq</p> <p>6. mnR mgm`v mgvavb Rb` mgxKiY MVtb AvMbx nte </p>	<ul style="list-style-type: none"> • mij mnmgxKiYi aviYv • cîZ`vcb I Acbqb c×wZtZ mij mnmgxKiYi (wPj K) mgvavb, MVb I Zv tj LwPti còkè • tj LwPti mnmvth` mij mnmgxKiYi mgvavb 	<ul style="list-style-type: none"> • vkyK còkèE`ti gva`tg vkyv`i mij mgxKiYi ce`Avb hvPvB Kiteb vkyK D`vniYi mnmvth` mij mnmgxKiY Kx Zv eYèv Kiteb • vkyK cîZ`vcb I Acbqb c×wZtZ mij mnmgxKiYi mgvavb tKSkj I MVb còkè D`vniYmn e`vL`v Kiteb vkyv`i G c×wZtZ mgm`v mgvavb Abkxj b KiZ ej`teb còqvRtb vkyK mnmvZv Kiteb • vkyv`i v QK KvM`R we`jcvZb Kti tiLv A`b Kite vkyK QK KvM`R mij mgxKiYi wPti A`b Kti mgvavb tKSkj nvZ Kj`tg Kti t`Lvte cîZ`K vkyv`i QK KvM`R mij mnmgxKiYi mgvavb Abkxj b Kite còqvRtb vkyK mnmvZv Kiteb 	<ul style="list-style-type: none"> • tkèYi KvR w`tq vbw`è gvb`tèi wfvèZtZ gj`vqb Kiteb • ewoi KvR w`tq vbw`è gvb`tèi wfvèZtZ gj`vqb Kiteb • ev`bvwfvèK mgm`v mgvavb KiZ w`tq gj`vqb Kiteb • nvZ Kj`tg KvR w`tq QK KvM`R we`jcvZb gj`vqb Kiteb

მისგ აა'ვq : tmU

(10 უცნი q/W)

ukLbdj	vel qe'	ukLb-tkLvtbv vbt` Rbv	gj`vqb vbt` Rbv
<p>ეპ`ეჰი</p> <ol style="list-style-type: none"> 1. tmU I tmU MvB cჰuqv e`vL`v KiჰZ cviჰe 2. mmxg tmU, mweR tmU, ciK tmU, dviKv tmU, vbtñ` tmU eYᅇv KiჰZ cviჰe Ges Zv`i MvB cZxჰKi mvrnჰh` cKvk KiჰZ cviჰe 3. GKwaK tmჰUi msthM tmU, tQ` tmU MvB I e`vL`v KiჰZ cviჰe 4. tfbvPĪ I D`vniჰYi mvrnჰh` tmU cჰuqvi mnR agvᅇij hvPvB I cᅇvY KiჰZ cviჰe 5. tmჰUi agvᅇij cᅇqM Kჰi mgm`v mgvavb KiჰZ cviჰe <p>AvჰeMxq</p> <ol style="list-style-type: none"> 6. tfbvPĪi mvrnჰh` MmYvZK mgm`vჰK bv`wbK fჰჰe Dc`vcჰb mჰPᅇ nჰe 	<ul style="list-style-type: none"> • tmU • weifbæcKvi tmU (mmxg tmU, mweR tmU, ciK tmU, dviKv tmU, vbtñ` tmU Gi eYᅇv I MvB) • tmჰUi msthM I tQ` • tfbvPĪ • tmჰUi agvᅇij (ciK, msthM I tQ`) 	<ul style="list-style-type: none"> • wkyK weifbæ` A_ev vPĪi mvrnჰh` tmU I DcჰtmჰUi aviYv D`vniYmn tefWᅇvL`v Kiჰeb • wkyv_ჰ`i mvrnჰZvq wkyK tmU cKvჰki weifbæDcvq I MvB cჰuqv tefWᅇKჰi t`Lvჰeb wkyv_ჰ`v weifbæDcvჰq tmU MvB Kჰi wkyKჰiK t`Lvჰe cᅇqvRჰb wkyK mvrnჰZv Kiჰeb • wkyK tfbvPĪi mvrnჰh` tmჰUi msthM I tQ` cჰuqv tefWᅇYᅇv Kiჰeb cᅇZ`K wkyv_ჰ`tfbvPĪi mvrnჰh` tmჰUi msthM I tQ` LvZvq vbyᅇ Kiჰe cᅇqvRჰb wkyK mvrnჰZv Kiჰeb 	<ul style="list-style-type: none"> • wkyv_ჰ`i tefWᅇWჰK tfbvPĪ AuKჰZ w`tq gj`vqb Kiჰeb • tKᅇYi Kvr w`tq vbw`ᅇ gvb`ჰEi wfvᅇჰZ gj`vqb Kiჰeb • ev`ewfvᅇK mgm`v mgvavb KiჰZ w`tq gj`vqb Kiჰeb

wLbdj	vel qe`	wLb-tkLvfbv vbt` Rbv	gj`vqb vbt` Rbv
<p>gtbv`cukR</p> <p>3. c0 È DcvÈ ntZ i aj vi I K`úm e`envi Kti PZfR AukìZ cvi te </p> <p>4. AvqZvKvi Nbe`i wPì AukìZ cvi te </p> <p>5. wì fR mti i mrvth` PZfR tyti tytdj cwi gvc KitZ cvi te </p> <p>6. AvqZvKvi Nbe`i I NbtKi ct0i tytdj cwi gvc KitZ cvi te </p>	<ul style="list-style-type: none"> • tKvfbv PZfRi wZbu evui `N`I ASfP` BwU tKvY t`I qv`vKtj PZfRw AukìZ nte • tKvfbv PZfRi `BwU evu Ges wZbu tKvY t`I qv`vKtj PZfRw AukìZ nte • AvqZvKvi Nbe`i I NbK • PZfR tyti tytdj cwi gvc 	<ul style="list-style-type: none"> • wkyK Wv`vi, BU, eB, PK ev- BZ`w`i gra`tg Nbe`i Ges j Wi Q`v I i`ek-wKdtei mrvth` NbtKi avi Yv e`vL`v Kitèb Gfite wZb gv`vi R`wgvZK e`i mvt` cwi wPZ Kitèb wky`v`Pv wky`ti mnt`hwMZvq Nbe`i,tjv cwi gvc Kitèb 	<ul style="list-style-type: none"> • ter`Wwky`v`P i tWtK wewfbae ai`bi A`b KitZ w`tq hvPvB Kitèb • nvtZ Kj tg wewfbaNbe`i cwi gvc KitZ w`tq ch`ey`ti gra`tg gj`vqb Kitèb

beg Aa`vq : uc_vtMvivtmi Dccv` (12 ucvi qW)

wLbdj	vel qe`	wLb-tkLvtbv vbt` Rbv	gj`vqb vbt` Rbv
<p>epxeExq</p> <p>1. uc_vtMvivtmi Dccv` hvPvB Kti evL`v KitZ cvi te </p> <p>2. wL fRi wZbuU evui `N` t` lqv_vKtj wL fRuU mgtKvYx wKbv-hvPvB KitZ cvi te </p> <p>3. uc_vtMvivtmi Dccv` cgvY KitZ cvi te </p> <p>4. uc_vtMvivtmi m` e`envi Kti mgm`v mgvavb KitZ cvi te </p>	<ul style="list-style-type: none"> uc_vtMvivtmi Dccv` hvPvB, cgvY l cQqM 	<ul style="list-style-type: none"> wkyv_xPv wevfbogvtci wZbuU mgtKvYx wL fR GtK evu` t`jvi `N` cwi gvc Kite wL fRi cZwU evui `N`K eMpyt`i GKwU evu` a`i tyTdj wbyq Kite G t`K wkyK uc_vtMvivtmi Dccv` hvPvB KitZ mnthwMZv Kiteb wkyK wP`T, gtWj BZ`w` i mnvth` wkyv_xP` i mnthwMZvq uc_vtMvivtmi Dccv` wU cgvY Kiteb wkyK ev`bwfwEK D`vni`yi mnvth` uc_vtMvivtmi Dccv` wU cQqM Avtj vPbv Kiteb wkyv_xPv cO`E mgm`v `tj mgvavb Kite 	<ul style="list-style-type: none"> wkyK chfeyY l cOkwEti i gva`tg gj`vqb Kiteb terfw`wkyv_xP` i twtK Dccv` wU cgvY KitZ w`tq hvPvB Kiteb tkOyi KvR l tkOY Awfyvi mnvth` gj`vqb Kiteb

kg Aa`vq: eĚ (15 ucui qW)

wLbdj	vel qe`	wLb-tkLvtbv vbt` Rbv	gj`vqb vbt` Rbv
<p>ep`eĚxq</p> <ol style="list-style-type: none"> 1. eĚi aviYv jvf KiĚZ cvi te 2. cvB(π) Gi aviYv e`vLv KiĚZ cvi te 3. eĚvKvi tyġi tyġdj I cvi mxgv vbyġ Kti mgn`v mgvavb KiĚZ cvi te 4. eĚ mspvšl Dccv` cġvY KiĚZ cvi te 5. eĚ mspvšl Dccv` cġvM Kti mgn`v mgvavb KiĚZ cvi te <p>gtbv`cukR</p> <ol style="list-style-type: none"> 6. cvi gvc wdzv e`envi Kti eĚvKvi tyġi cvi mxgv I tyġdj cvi gvc KiĚZ cvi te 7. PZfR I eĚi tyġdj i mrvth` tej tbi cġi tyġdj cvi gvc KiĚZ cvi te 	<p>eĚ</p> <ul style="list-style-type: none"> • eĚi aviYv (tk`^a; R`v, e`vm, e`vma^o, cwi va) • cvB(π) Kx, cvB(π) Gi cvi vPvZ I cvB(π) Gi gvb • eĚvKvi tyġi tyġdj I cvi mxgvi cvi gvc <p>Dccv` cġvY I cġvM</p> <ul style="list-style-type: none"> • eĚi tk`^a Ges th tkvtbv R`v Gi ga`v`j msthvRK mij ti Lv H R`v Gi Dci j ae • eĚi mKj mgvb R`v tk`^a t`K mg`ieZi^o • eĚ mspvšl mgn`v <ul style="list-style-type: none"> • tej b 	<ul style="list-style-type: none"> • wġv`_{flv} th tkvtbv eĚ GtK Zvi cvi mxgv I e`vmi AbcvZ vbyġ Kite cġZw eĚi tyġi GB AbcvZi gvb th mgvb Zv ej te Gi gra`tg wġyK cvB(π)-Gi aviYv t`teb • wġv`_{flv} eĚi e`vma^o tgc wvfbvAvKvti i eĚi tyġdj tei Kite • wġv`_{xpv} eĚ mskvšl Dccv` , tj v wPġ GtK hvPvB Kite wġv`_{xpv} wġyġKi msthvMZvq Dccv` , tj v cġvY Kite • wġv`_{xpv} Dccv` cġvM Kti mgn`v mgvavb Kite • wġv`_{xpv} nvtZ-Kj tg tej tbi tyġdj vbyġ Kite wġyK cġvRtb mrvqZv Kite 	<ul style="list-style-type: none"> • eĚ GtK cvi gvc Kivi mgq wġyK wġv`_{xpv} i KvR Nġi Nġi chġyY Kiteb Ges tgšwLK cġkġi i gra`tg gj`vqb Kiteb • wġv`_{xpv} i GKKfite LvZvq AvKġZ w`tg gj`vqb Kiteb • tkġi KvR I tkġ Avfġvi mrvth` gj`vqb Kiteb • cvi gvc Kti tyġdj vbyġ Kivi mgq wġyK chġyY Kiteb Ges cġkġi i gra`tg wġv`_{xpv} i tK gj`vqb Kiteb

GKv`k Aa`vq : Z` I DcvE

(15 vcn qW)

wLbdj	vel qe`	wLb-tkLvtbv wbt` Rbv	gj`vqb wbt` Rbv
<p>ep`eE`xq 1. tK`xq cEYZv e`vL`v KiZ cvite 2. MwYvZK mfi mrvth` Mo, ga`K I cPi K wYq Ki mgn`v mgvavb KiZ cvite 3. cvBvP` e`vL`v KiZ cvite </p> <p>gtbv`cukR 4. cvBvP` A`b KiZ cvite </p>	<ul style="list-style-type: none"> • tK`xq cEYZv • Mo, ga`K I cPi K • cvBvP` 	<ul style="list-style-type: none"> • wYv`xv AvRZ ceAv`bi gva`tg tK`xq cEYZvi aviYv e`vL`v KiTe wYK wevfbD` vni`yi mrvth` wYv`xv i aviYv my`uo KiTe • wYv`xv Mo, ga`K I cPi`Ki mfi`_tjv wYv`Ki mrvqZvq `j MZfvte PvU`AvKv`i c`k`b KiTe mfi`_tjv AvqE` Ki wYv`Ki mrvqZvq MwYvZK mgn`vi mgvavb KiTe wYK c`qvR`b mrvqZv KiTe • wYv`xv e`enwi Kfvte Aveb`-I DcvE`K wev`-I AvKv`i c`k`k Ki cvBvP` A`b KiTe Ges wYK c`qvR`b mrvqZv KiTe • wYK tccvi ev wevfbD`rm nZ` cvBvP` Dc`vcZ Z` mieivn KiTe wYv`xv vP`v e`vL`v KiTe c`hvR` ty`f` wYK mrvth`MZv KiTe • wYK weMZ `B`-wZb eQi i we`vj tqi cvtmi DcvEmgn wYv`xv i mieivn KiTe wYv`xv `j MZfvte weMZ eQi`_tjvi Mo cv`ki nvi wYq KiTe c`B DcvE` nZ` MwYv, BstivR I weAvb vel`tqi c`B b`fi i wvE`Z Mo ,ga`K I cPi K wYq KiTe Ges c`Zte`b AvKv`i Dc`vcb KiTe 	<ul style="list-style-type: none"> • tK`xq cEYZvi aviYv e`vL`v Kivi mgq tg`LK c`k`E`i gva`tg gj`vqb KiTe • wba`v Z gvb``Ei mrvth` `j MZ KvR gj`vqb KiTe • tK`Yi KvR I tK`Y Avf`yvi mrvth` gj`vqb KiTe • wba`v Z KvRi gvb``Ei mrvth` gj`vqb KiTe

11. Aóg tkwYi MwZ eBtqi Rb` tj LK wbt` Rbv

cŃg Aa`vq : c`vUvb©

1. wefboaiþbi msL`v, Ayi, msL`vfiLv, t`ktj L, R`vgnZK wPÎ BZ`w`i gra`tg c`vUvbP avi Yv e`vL`v w` tZ nte |
2. thvM, weqvm, Ÿ Y I fvm cŃqvi gra`tg c`vUvbP avi Yv I MVb D`vniþYi mvrth` e`vL`v w` tZ nte |
3. c`vUvbP gra`tg msL`v I Ayi msewj Z cvRj , tMgm Ges wefvR`Zv wefboD`vni Y w` tQ Dc`vcb Ki tZ nte |
4. `i vLK c`vUvbP K tj LwPÎ cŃkþbi tKSkj ev wqg e`vL`v mn`vKte |
5. msL`vrfwEK tLj v`Zwi i Rb` wkŸv`K K Kiv Kivi mþhvM`vKtZ nte |
6. chwß Abkxj bx`vKte |

wZxq Aa`vq : gþvdv

1. mij gþvdv I Pµewx gþvdi ev`wrfwEK D`vniþYi gra`tg Avtj vPbv`vKte |
2. mij gþvdv I Pµewx gþvdi wbyŸqi mþti e`vL`v w` tZ nte |
3. mij gþvdv I Pµewx gþvdi ev`e wrfwEK mnR t`tk RwJ Zi D`vniþYi mvrth` mþti cŃqvm t`LvZ nte |
4. mij gþvdv I Pµewx gþvdi Rxeb NwbŃ MwYwZK mgm`v msewj Z Abkxj bx`w` tZ nte |

ZZxq Aa`vq : cwi gvc

1. wPÎ I D`vniþYi mvrth` t`kxq , weUk I AvSRwZK cxwZtZ ``NŃ, tŸt`dj , I Rb Ges Zij c`vt`P AvqZb cwi gvtci e`vL`v Ki tZ nte |
2. t`kxq, weUk I AvSRwZK cxwZtZ ``NŃ, tŸt`dj , I Rb Ges AvqZb cwi gvtci OK w` tZ nte |
3. D`vniþYi mvrth` t`kxq , weUk I AvSRwZK cxwZi Avštm`ut`Kp e`vL`v w` tZ nte |
4. Rxeb NwbŃ MwYwZK mgm`v msewj Z Abkxj bx`w` tZ nte |

PZL`Aa`vq : exRMwYzq mfvewj I cŃqvm

1. wŃc`x I wŃc`x iwki eMŃ Nb wbyŸqi mfvewj I Abyxvšš e`vL`v`vKte | m`te` tŸt` R`vgnZK e`vL`v w` tZ nte |
2. eMŃ Nþbi mþti mvrth` wŃc`x I wŃc`x iwki Nb wbyŸ tKSkj i D`vniYmn e`vL`v`vKte |
3. ga`c` wekt`þYi mvrth` Drcv`tk wekt`Y wbyŸqi cxwZ D`vniþYi gra`tg e`vL`v w` tZ nte |
4. exRMwYzq iwki M.mv. Ÿ I j.mv. Ÿ wbyŸqi e`vL`v mn`vKte D`vniY`vKte |
5. chwß I wLbdj ARŃ DcþhvMx mgm`v msewj Z Abkxj bx`vKte |

cĀg Aa`vq : exRMmYZxq fMsk

1. exRMmYZxq i wkgvj vi thvM, wētqvM, ſY I fVm cĀqv i eYḐvnm D`vniY _vKte|
2. thvM, wētqvM, ſY I fVm msewj Z mij xKiḑYi e`vL`vnm D`vniY I Abkxj bx _vKte|

Iô Aa`vq : mij mnmgxKiY

1. mij mnmgxKiḑYi aviYv e`vL`vnm D`vniY _vKte|
2. cĀZ`vcb I Acbqb c×wZḑZ wḐPj K wēkó mij mnmgxKiḑYi mgvavḑbi tKŠkj I MVb cĀqv D`vniYmn e`vL`v _vKte|
3. mij mnmgxKiḑYi mgvavb tj LuPĪ cĀkēbi tKŠkj I tj LuPĪ t_ḑK mij mnmgxKiḑYi mgvavḑbi tKŠktj i eYḐv _vKte|
4. chwḐ D`vniY I Abkxj bx _vKte|

mBq Aa`vq : tmU

1. ev`é RMḑZi e`ĵ A_ev wPĪi mvrḑth` tmU I DcḑtmḑUi e`vL`v w`ḑZ nte|
2. tmU cKḑḑki Dcvq, wēfbœckvi tmḑUi eYḐv I MVb cĀqv D`vniḑYi mvrḑth` e`vL`v KiḑZ nte|
3. ev`é D`vniḑYi mvrḑth` tmḑUi msthvM I tQ` cĀqv e`vL`v w`ḑZ nte|
4. tfbwPĪ I D`vniḑYi mvrḑth` tmḑUi agvēwj hvPvB I cĀvY cĀqv eYḐv w`ḑZ nte|
5. tmḑUi agvēwj cĀqv Kḑi mgm`vi mgvavḑbi Rb` chwḐ D`vniY I Abkxj bx _vKte|

Aóg Aa`vq : PZfR

1. wēfbœckvi ev`é wPĪi mvrḑth` PZfR `Zwi i e`v _vKte|
2. PZfRi agvēwj _vKte|
3. PZfR mspvšlm=úv` mWk fḑe wPĪi gvātg eYḐv _vKte|
4. wPĪ Aḑḑbi tKŠkj I Aḑḑbi h_v`Zvi e`vL`v _vKte|
5. Abkxj bx _vKte|
6. wēfbœckvi ev`é wPĪi Nbe`i wPĪ _vKte Ges G t_ḑK wZb gvĪvi R`wguZK aviYvi Dc`vcb _vKte|
7. Nbe`mgḑni tḑḑdj cwigvḑci wPĪmn eYḐv _vKte|

beg Aa`vq : wc_vtMvivtmi Dccv`

1. ce@vtVi cpi vtj vPbv _vKte|
2. weifb@gtci mgtKvYx wî fîRi wPÎ _vKte| mgtKvYx wî fîRi cîZwU evûi Dci eMÿÿÎ A¼tbi wbt` Rbvmn wPÎ I evL`v _vKte|
3. wZbuU evû t` lqv _vKtj wî fRwU mgtKvYx wKbv Zv hvPvB Kivi wbt` Rbv _vKte|
4. wPÎi mrvvth` wc_vtMvivtmi Dccv`i c@vY _vKte|
5. D`vniÿYi mrvvth` wc_vtMvivtmi mÿÎi c@qM _vKte|
6. Abkxj bx _vKte, wc_vtMvivtmi mÿ e`envi Kti mgvavb Kiv hvq Giyc weifb@ngm`v _vKte|

`kg Aa`vq : eË

1. ev`é wPÎi mrvvth` eÿEi Pvc, R`v, e`vm, e`vmva@PwÿZ Kiv _vKte|
2. eÿEi e`vm, R`v, e`vmva@cwi wa, tK`eY@v _vKte|
3. eË mspvšlDccv` I Zv`i wPÎmn hvÿgj K c@vY _vKte|
4. eË mspvšlDccv` c@qM Kti ev`éwfvËK mgm`vi mgvavb mspvšlD`vniY _vKte|
5. ev`é D`vniÿYi gra`tg tej tbi c@i tyÿdj cwigtci eY@v _vKte|
6. Abkxj bx _vKte|

GKv`k Aa`vq : Z` I DcvË

1. ev`é wfvËK D`vniÿYi mrvvth` tK`xq c@YZvi evL`v w` tZ nte|
2. Mo, ga`K I c@i K wbyqci mÿ D`vniÿYi mrvvth` evL`v w` tZ nte|
3. cvBwPÎi mrvvth` Z` I DcvË wKfvte mntR Dc`wcz nq Zv D`vniÿYi mrvvth` evL`v Ki tZ nte|
4. cvBwPÎ A¼tbi wbgg evL`v Ki tZ nte|
5. Mo, ga`K I c@i K wbyqci mÿ c@qM Kivi Rb` c@Z`wnK Rxe tb weifb@wtÿÿÿi DcvË e`envi Kti D`vniY Ges Abkxj bx w` tZ nte|

rkjvug

MWZ

beg l `kg tkö

2. Dfík

1. MmYwZK Ávb I `bcy" ARB Kivi gra"tg thš³K I MVbgj K wPšiq D0x nl qv|
2. MmYwZK hy³ e"envi Kti e"wbô c0vtY DcbxZ nl qvi `ýZv ARB Kiv|
3. tmU I tmUi Kvh0wa m0útkRvbn Ges mgnv mgravtb tmU e"envtii `ýZv ARB Kiv|
4. dsktbi avi Yv jvf Kti tj LwPĀ A¼b Ges Zv c0qvM KiþZ mýg nl qv|
5. ev"é msL"vi tk0web"vm m0úfk Rvbn I c0qvM KiþZ cviv|
6. ev"é mgnv mgravtb exRMmYwZK mĀi MVb I e"envi Kivi `ýZv ARB Kiv|
7. mPK I j Mwi`g m0útkR avi Yv jvf I c0qvM mýg nl qv|
8. exRMmYwZxq AbcvZ I mgnvctZi avi Yv jvf I c0qvM mýg nl qv|
9. GK Pj Kweikó mgnKiY Ges `ß Pj Kweikó mij mnmgnKiY mgravb I c0qvM `ýZv ARB Kiv|
10. Abjg I avivi avi Yv jvf, mnxg mgnšĀ I ,tYvEi avivi wbn"0 c` Ges wbn"0 msL"K ct`i mgnó wby0 KiþZ cviv|
11. R"mgnZK c0vY I R"mgnZK A¼b m0útkÁvb m0útmviY I Zv c0qvMi `ýZv epx Kiv|
12. c0ZmgZv I m`kZv m0útkÁvb jvf Kti Zv e"envi KiþZ mýg nl qv|
13. wĀtkvYmgnZK AbcvZ m0útkÁvb jvf Kti c0qvM KiþZ cviv|
14. mgZj xq týtĀ I Nbe"msmšĀcwi gvc KiþZ mýg nl qv |
15. Z" I DcvE web"vtmi gra"tg cwi msL"vtbi tgnj K wclqwn` Rvbn I c0qvM KiþZ cviv|
16. MmYwZK mgnv mgravtbi Dcvq D"tefb `bcy" jvf Kiv|

3. Aa`vq wfvEK ucniqW eEb

beg tkv-1g tmg ÷ vi	Aa`vtqi wktivbvg	ucniqW	cpivtjvPbvi Rb` eivI KZ ucniqW
1.	ev`e msL`v	15	5
2.	tmU I dviskb	15	5
3.	exRMwYwZK i wik	10	3
4.	tiLv, tKvY I wI fR	10	3
5.	e`enwi K R`wgvZ	6	2
6.	wI tKvYwgvZK AbjvZ	8	3
7.	cwi wgvZ	8	3
		72	24
beg tkv-2q tmg ÷ vi			
1.	mPK I j Mwi`g	10	3
2.	exRMwYwZxq AbjvZ I mgvbjvZ	12	4
3.	GK Pj Kwekó mgvKiY	10	3
4.	eE	14	5
5.	tjI dj m`u`wKZ Dccv` I m`u`v`	12	4
6.	wI tKvYwgvZK AbjvZ	8	2
7.	cwi wgvZ	6	3
		72	24
`kg tkv-1g tmg ÷ vi			
1	`B Pj Kwekó mij mngvKiY	10	3
2.	mngv aviv	12	4
3.	AbjvZ, m`kZv I cWmgZv	20	7
4.	`iZi I D`PZv	10	3
5.	cwi wgvZ	8	3
6.	cwi msL`vb	12	4
		72	24
`kg tkvI 2q tmg ÷ vti m`u`v` mtjv tmi I ci vbePvb cixv AbjvZ nq ZvB `kg tkvI 2q tmg ÷ vti eivI KZ 72 ucniqW mKj Aa`vtqi cpivtjvPbvi Rb` eivI ivLv ntqtQ			

4. $\mathbb{K} \times \mathbb{N} \times \mathbb{K}$
 $\text{beg} - \text{kg tkö}$

ՎՅՋԱԳ ԱԲՆՈՒՄ : ԻՄՈՒՆ ԸՆԿՆԵՐ (15 ՎԵՐՈՒՅՈՒՄ)

Էջ 2

ՎԵՐՈՒՅՈՒՄ	ՎԵՐՈՒՅՈՒՄ	ՎԵՐՈՒՅՈՒՄ	ՎԵՐՈՒՅՈՒՄ	ՎԵՐՈՒՅՈՒՄ
<p>9. ԻՄՈՒՆ Ի ԻՄՈՒՆ ԸՆԿՆԵՐ ԸՆԿՆԵՐ</p> <p>10. ԸՆԿՆԵՐ ԻՄՈՒՆ Ի ԻՄՈՒՆ ԸՆԿՆԵՐ</p> <p>ԳՆԱԿԱՆ</p> <p>11. ԸՆԿՆԵՐ ԻՄՈՒՆ ԸՆԿՆԵՐ ԸՆԿՆԵՐ</p>	<ul style="list-style-type: none"> • ԸՆԿՆԵՐ ԻՄՈՒՆ ($x=a, y=b, y = mx+c$) 	<ul style="list-style-type: none"> • ԸՆԿՆԵՐ ԸՆԿՆԵՐ ԻՄՈՒՆ ԸՆԿՆԵՐ • ԸՆԿՆԵՐ ԸՆԿՆԵՐ ԻՄՈՒՆ ԸՆԿՆԵՐ 	<ul style="list-style-type: none"> • ԸՆԿՆԵՐ ԸՆԿՆԵՐ ԸՆԿՆԵՐ • ԸՆԿՆԵՐ ԸՆԿՆԵՐ • ԸՆԿՆԵՐ ԸՆԿՆԵՐ ԸՆԿՆԵՐ 	<ul style="list-style-type: none"> • ԸՆԿՆԵՐ ԸՆԿՆԵՐ ԸՆԿՆԵՐ

ZZxq Aa`vq : exRMwYwZK i wk (10 wcvu qW)

wkLbdj	vel qe`'	wkLb-tkLvfbv vbt` Rbv	gj`vqb vbt` Rbv	wetkl tj LK vbt` Rbv
<p>exRMwYwZK</p> <p>1. exRMwYwZK mĤ cĦqM KĤi eMĦ NĤbi mᵘŭthvi Y KiĤZ cviĤe </p> <p>2. fVMĤkl Dccv` Kx e`vL`v KiĤZ cviĤe Ges Zv cĦqM KĤi Drcv`ĤK wetkl Y KiĤZ cviĤe </p> <p>3. ev`ĕ mgm`v mgvavĤbi Rb` exRMwYwZK mĤ MVb KiĤZ cviĤe Ges mĤ cĦqM KĤi mgm`v mgvavb KiĤZ cviĤe </p>	<ul style="list-style-type: none"> eMĦ NĤbi mᵘŭthvi Y fVMĤkl Dccv` cĦqM KĤi Drcv`ĤK wetkl Y ev`ĕ mgm`v mgvavĤb exRMwYwZK mĤ MVb I cĦqM 	<ul style="list-style-type: none"> exRMwYwZxq iwki eMĦ Nb wbyĤqi mĤvejij I G msμvšI AbymŬvĤšI Dc`vcb I AvĤj vPbv mĤvejij i R`wgmZK e`vL`v Dc`vcb exRMwYwZxq Pj K cwi eZĦ KĤi eMĦ NĤbi mᵘŭthvi Y I Drcv`ĤK wetkl Y Kiv wel qK AvĤj vPbv wŦNvZ AvKvĤi i thĤKvĤbv iwki Drcv`ĤK wetkl Y Kivi tKškj eYĦv D`vniĤYi gva`tg fVMĤkl Dccv`i e`vL`v fVMĤkl Dccv` e`envi KĤi Drcv`K wetkl ĤY mnvqZv cĦvb ev`ĕ mgm`vi exRMwYwZxq mĤ MVb msμvšI AvĤj vPbv Ges mĤ cĦqM i gva`tg mgm`v mgvavĤb mnvqZv cĦvb 	<ul style="list-style-type: none"> exRMwYwZxq iwki cwi eZĦ KĤi eMĦ NĤbi mĤi ceĤvb hvPvB mĤ cĦqM KĤi Drcv`ĤK wetkl Y Drcv`ĤK wetkl Y wel qK emoi Kiv Ges tkĦY Afxyv fVMĤkl Dccv` cĦqM KĤi Drcv`ĤK wetkl Y mĤ MVb I mgvavĤbi `yZv hvPvB 	<ul style="list-style-type: none"> eMĦ NĤbi mᵘŭthvi Y KĤi Drcv`ĤK wetkl Y D`vni Ymn eYĦv _vKĤe $(a + b + c)^2, (a + b)^3, (a - b)^3, a^3 + b^3, a^3 - b^3$ mĤi cĦqM _vKĤe $px^2 + qx + r$ AvKvĤi i iwki Drcv`ĤK wetkl Y _vKĤe fVMĤkl Dccv` D`vni Ymn eYĦv _vKĤe Ges Zv cĦqM KĤi Drcv`ĤK wetkl Y Kivi c×wZi e`vL`v _vKĤe ev`ĕ mgm`v mgvavĤbi Rb` exRMwYwZK mĤ MVĤbi c×wZi eYĦv Ges mgm`v mgvavĤbi Abkj bx _vKĤe

PZL[®] Aa`vq : mPK I j Mwi`g (10 ucviqW)

vkLbdj	vel qe`	vkLb-fkLvfbv vbt` Rbv	gj`vqb vbt` Rbv	vefkl tj LK vbt` Rbv
<p>epxeEiq</p> <ol style="list-style-type: none"> 1. gj` mPK e`vL`v KiZ cvi te 2. abvZK cY`msvL`K mPK, kb` I FYvZK cY`msvL`K mPK e`vL`v I c`qM KiZ cvi te 3. mP`Ki vbgvej eY`v Ges Zv c`qM Kti mgm`vi mgravb KiZ cvi te 4. n-Zg gj` ($n \in \mathbb{N}$) Ges gj` fMsk mPK e`vL`v KiZ cvi te 5. n-Zg gj`K mPK AvKrti cKvk KiZ cvi te 6. j Mwi`g e`vL`v KiZ cvi te 7. j Mwi`gi m`vevj c`vY I c`qM KiZ cvi te 8. mavi Y I `fweK j Mwi`g e`vL`v KiZ cvi te 9. msL`vi `e`vbk ifc Ges mavi Y j Mwi`gi cY`K I AskK e`vL`v KiZ cvi te <p>gtbt`c`kR</p> <ol style="list-style-type: none"> 10. K`vj Ktj Ut`i i mrvth` mavi Y I `fweK j Mwi`g vby`q KiZ cvi te 	<ul style="list-style-type: none"> • gj` mPK • mP`Ki vbgvej <ul style="list-style-type: none"> ◦ $a^m a^n = a^{m+n}$ ◦ $\frac{a^m}{a^n} = a^{m-n}$ ◦ $(a^m)^n = a^{mn}$ ◦ $(ab)^n = a^n b^n$ ◦ $\left(\frac{a}{b}\right)^n = \frac{a^n}{b^n}$ • n-Zg gj` I gj` fMsk mPK • j Mwi`g • j Mwi`gi m`vevj <ul style="list-style-type: none"> ◦ $\log_a a = 1$ Ges $\log_a 1 = 0$ ◦ $\log_a (MN) = \log_a M + \log_a N$ ◦ $\log_a \left(\frac{M}{N}\right) = \log_a M - \log_a N$ ◦ $\log_a M^r = r \log_a M$ • mavi Y I `fweK j Mwi`g • msL`vi `e`vbk ifc, j Mwi`gi cY`K I AskK 	<ul style="list-style-type: none"> • abvZK cY`msvL`K, kb` I FYvZK cY`msvL`K mPK msevj Z PvU`Dc`vcb I e`vL`v • mP`Ki tgšvj K vbgvej c`vY, e`vL`v I c`qM Kti mgm`v mgravb • kb` mP`Ki e`vL`v • D`vni`Yi gra`tg n-Zg gj`K mPK AvKrti cKvk I e`vL`v • j Mwi`gi (tgšvj K m`vevj) c`vY, e`vL`v I c`qM Kti mgm`v mgravb • mavi Y I `fweK j Mwi`gi m`vut`K e`vL`v • D`vni`Yi gra`tg msL`vi `e`vbk ifc Ges mavi Y j Mwi`gi cY`K I AskK Avtj vPbv 	<ul style="list-style-type: none"> • abvZK I FbvZK cY`msvL`K mP`Ki kbv`K i Y • mP`Ki tgšvj K vbgvej c`vY Kiv • mP`Ki tgšvj K vbgvej i mrvth` mgm`v mgravb Kiv • j Mwi`gi tgšvj K m`vevj c`vY, e`vL`v I c`qM Kti mgm`v mgravb • K`vj Ktj Ut`i i mrvth` mavi Y I `fweK j Mwi`g mspvšl mgm`vi Abkxj b 	<ul style="list-style-type: none"> • gj` mPK D`vni`Ym e`vL`v vKte [abvZK cY`msvL`K mPK, kb` I FYvZK cY`msvL`K mP`Ki eY`v vKte • mP`Ki vbgvej i eY`v Ges Zv c`qM mgm`vi mgravb vKte • n Zg gj` I gj` fMsk mPK D`vni`Ym e`vL`v vKte • j Mwi`gi D`vni`Ym eY`v vKte • j Mwi`gi m`vevj i Ges Zv c`qM mspvšl mgm`vi mgravb vKte • mavi Y I `fweK j Mwi`gi D`vni`Ym e`vL`v vKte • msL`vi `e`vbk ifc, mavi Y j Mwi`gi cY`K I AskK D`vni`Ym eY`v vKte Ges Zv vby`qj Abkxj bx vKte • K`vj Ktj Ut`i i mrvth` mavi Y I `fweK j Mwi`g vby`qj cxvzi e`vL`v vKte Ges mgm`vi mgravb Abkxj bx vKte

cÂg Aa`vq : GK Pj Kueikó mgxKiY (10 vci qW)

vklbdj	velqe`	vklb-`tkLv`bv vbt` Rbv	gjj`vqb vbt` Rbv	vetki tj LK vbt` Rbv								
<p>ey`eE`vq</p> <ol style="list-style-type: none"> 1. mgxKiY I A`f`i cv`R` e`vL`v Ki`Z cvi`te 2. GKvZ mgxKi`Yi mgvavb Ki`Z cvi`te 3. ev`l`w`f`w`E`K mgm`vi mgxKiY MVb K`ti mgvavb Ki`Z cvi`te 4. w`NvZ mgxKi`Yi mgvavb Ki`Z cvi`te Ges mgvavb tmU vbY`q Ki`Z cvi`te 5. ev`l`w`f`w`E`K mgm`vi w`NvZ mgxKiY MVb K`ti mgvavb Ki`Z cvi`te <p>Av`teM`vq</p> <ol style="list-style-type: none"> 6. mgxKiY MVb K`ti mgm`vi mgvavb Av`M`v n`te 	<ul style="list-style-type: none"> • mgxKiY I A`f` • GKvZ mgxKi`Yi mgvavb • w`NvZ mgxKiY • w`NvZ mgxKi`Yi mgvavb I mgvavb tmU • ev`l`w`f`w`E`K mgm`vi mgvavb 	<ul style="list-style-type: none"> • mgxKiY I A`f`i cv`R` Dc`vcb • GKvZ mgxKi`Yi mgvavb I ev`l`w`f`w`E`K mgm`vi mgxKiY MVb • w`NvZ mgxKi`Yi mgvavb I mgvavb tmU vbY`qi vel`q Dc`vcb • ev`l`e mgm`vi w`f`w`E`Z w`NvZ mgxKiY MVb t`K`skj Dc`vcb 	<ul style="list-style-type: none"> • `eikó`vej eY`v <table border="1" data-bbox="1381 375 1614 496"> <thead> <tr> <th>mgxKiY</th> <th>A`f`</th> </tr> </thead> <tbody> <tr> <td>1.</td> <td>1.</td> </tr> <tr> <td>2.</td> <td>2.</td> </tr> <tr> <td>3.</td> <td>3.</td> </tr> </tbody> </table> <ul style="list-style-type: none"> • mgxKiY MVb I mgvavb <p>ewoi KvR : w`NvZ mgxKi`Yi mgvavb I mgvavb tmU vbY`q</p> <ul style="list-style-type: none"> • w`NvZ mgxKiY MVb I mgvavb 	mgxKiY	A`f`	1.	1.	2.	2.	3.	3.	<ul style="list-style-type: none"> • Pj`Ki D`vniYmn e`vL`v _vK`te • D`vniYmn mgxKiY I A`f`i e`vL`v _vK`te • GKpj Kueikó GKvZ mgxKiY mgvavb D`vniY I Ab`kj bx _vK`te • ev`l`e mgm`v mgvavb GKpj Kueikó GKvZ mgxKiY MVb I mgvavb c`q`M _vK`te • w`NvZ mgxKi`Yi e`vL`v _vK`te • w`NvZ mgxKi`Yi mgvavb I mgvavb tmU D`vniY I Ab`kj bx _vK`te • ev`l`e mgm`v mgvavb w`NvZ mgxKi`Yi MVb I e`enwi K c`q`M _vK`te
mgxKiY	A`f`											
1.	1.											
2.	2.											
3.	3.											

Iô Aa'vq : ti Lv, tKvY I wî fR

(10 vciwqW)

wklbdj	welqe'	wklb-tklvfvb vbt` Rbv	gj`vqb vbt` Rbv	wetkl tj LK vbt` Rbv
<p>eyxeExq</p> <p>1. mgZj xq R`wgvzi tgšuj K `xKvh^otj v eYθv KitZ cvi te </p> <p>2. mgvšlij mij ti Lv mspvšl Dccv` , tj v cθvY KitZ cvi te </p> <p>3. wî fR mspvšl Dccv` , tj v cθvY KitZ cvi te </p> <p>4. wî fR mspvšl Dccv` I Abymxvšl , tj v cθqM e`envi Kti mgm`v mgvavb KitZ cvi te </p>	<ul style="list-style-type: none"> • mgZj xq R`wgvzi tgšuj K `xKvh^o <ul style="list-style-type: none"> ○ mgvšlij mij ti Lv Dccv` ○ GKilU mij ti Lv Aci `βilU mgvšlij mij ti Lv tK tQ` mspvšl Dccv` I Zvi wecixZ Dccv` i cθvY • wî fR mspvšl Dccv` <ul style="list-style-type: none"> ○ wî fRi `βilU tKvY mgvb ntj Gt` i wecixZ evúθq ci`úi mgvb nte ○ wî fRi `βilU tKvY Amgvb ntj , epEi tKvYi wecixZ evú ži Zi tKvYi wecixZ evú Atcýv epEi nte ○ wî fRi `β evú ga`we`j msthvRK ti Lvsk ZZxq evú mgvšlij Ges` tN^o Zvi AtaR 	<ul style="list-style-type: none"> • R`wgvziK wpti i mrvth` BDKxW cô E tgšuj K `xKvh^ogn Avtj vPbv • `βilU mgvšlij mij ti Lv I GKilU tQ` K A%b Kti GKvšli tKvY I Abjfc tKvYi Dc`vcb • R`wgvziK wpti i mrvth` mgvšlij mij ti Lv mspvšl Dccv` I Zvi wecixZ Dccv` i cθvY Dc`vcb • R`wgvziK wpti i mrvth` wî fR mspvšl Dccv` i cθvY Dc`vcb • wî fR mspvšl Abymxvšl , tj v Avtj vPbv 	<ul style="list-style-type: none"> • `xKvh^ogn eYθv • mgvšlij mij ti Lv mspvšl Dccv` I Zvi wecixZ Dccv` i cθvYi eYθv • wî fR mspvšl Dccv` , tj v cθvY eYθv • Dccv` I Abymxvšl , tj v cθqM Kti mgm`v mgvavb 	<ul style="list-style-type: none"> • mgZj xq R`wgvzi tgšuj K `xKvh^otj vi e`vL`v _vKte • cθzh³i mrvth` cθvY /weixfvtei mrvth` cθvY (proof by contradiction) Gi aviYv e`vL`v Kti mgvšlij mij ti Lv I wî fR mspvšl Dccv` , tj v cθvYi eYθv _vKte Dccv` i mvt` msukó Abymxvšl msthvRb KitZ nte • wî fR mspvšl Dccv` I Abymxvšl , tj v cθqM Kti mgm`v mgvavb _vKte

mɓg Aa'vq : e'enwi K R'wgvZ

(06 vcnw qW)

wkLbdj	wel qe'	wkLb-ɬkLvɬbv ɪbɬ' Rbv	gj'vqb ɪbɬ' Rbv	wetkI tj LK ɪbɬ' Rbv
<p>eyxexq</p> <p>1. c0'É DcvÉ I Z'' e'enwi Kɬi wɪ fR A¼b KiɬZ cviɛ </p> <p>2. c0'É DcvÉ I Z'' e'enwi Kɬi mvgvšhi K A¼b KiɬZ cviɛ </p>	<ul style="list-style-type: none"> • weɪfɒæcKvi wɪ fR I PZfFR • wɪ fR msKɬšimæúv'' <ul style="list-style-type: none"> ○ wɪ fɬRi fɪg, fɪg msj Mæ GKwJ tKvY I Aci `β evú i mɔwó ɬ' I qv AvɬQ, wɪ fRwJ AvKɬZ nɛ ○ wɪ fɬRi fɪg, fɪg msj Mæ GKwJ mɔɬKvY I Aci `β evú i Ašli ɬ' I qv AvɬQ, wɪ fRwJ AvKɬZ nɛ ○ wɪ fɬRi fɪg msj Mæ βwJ tKvY I cwi mɔgv ɬ' I qv AvɬQ, wɪ fRwJ AvKɬZ nɛ • mvgvšhi K msKɬšimæúv'' <ul style="list-style-type: none"> ○ mvgvšhi ɬKi `βwJ KYQ Zvɬ' i Ašfɬ tKvY ɬ' I qv AvɬQ mvgvšhi KwJ AvKɬZ nɛ ○ mvgvšhi ɬKi `βwJ KYQ GKvJ evú ɬ' I qv AvɬQ mvgvšhi KwJ AvKɬZ nɛ 	<ul style="list-style-type: none"> • c0'É DcvÉ I Z'' e'enwi Kɬi weɪfɒæ aiɬbi wɪ fR A¼b I A¼ɬbi eYɬv Dc'vcb • c0'É DcvÉ I Z'' e'enwi Kɬi weɪfɒæ aiɬbi mvgvšhi K A¼b I A¼ɬbi eYɬv Dc'vcb 	<ul style="list-style-type: none"> • weɪfɒæɪɬbi wɪ fR A¼b • weɪfɒæɪɬbi mvgvšhi K A¼b 	<ul style="list-style-type: none"> • evú I tKvYi `enkɬó'i gva'ɬg wɪ fR I PZfFRi avi Yvi cpi vɬj vPbv _vKɛ • wɪ fɬRi evú I tKvY mæúmkɔ tKvb tKvb Z'' ɬ' I qv _vKɬj wɪ fR AvKv mæ Zv Kvɬɬɬgi mɪvɬh'' Dc'vcb KiɬZ nɛ • c0'É DcvÉ I Z'' e'enwi Kɬi wɪ fR A¼b _vKɛ • mvgvšhi ɬKi evú I tKvY mæúmkɔ tKvb tKvb Z'' ɬ' I qv _vKɬj mvgvšhi K AvKv mæ Zv Kvɬɬɬgi mɪvɬh'' Dc'vcb KiɬZ nɛ • c0'É DcvÉ I Z'' e'enwi Kɬi mvgvšhi K A¼b _vKɛ

А́ог Аа`vq : eĚ (14 vcviqW)

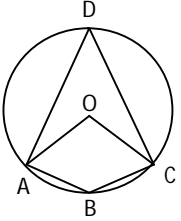
vklbdj	vel qe`	vklb-tklvtbv vbt` Rbv	gj`vqb vbt` Rbv	vetkl tj LK vbt` Rbv
<p>epxeĚvq</p> <p>1. eĚPvc , tk>`tKvY, eĚ`tkvY, eĚ Ašlj ĭLZ PZFR evL`v KitZ cvite </p> <p>2. eĚ m`umkZ Dccv` cġvY KitZ cvite </p>	<ul style="list-style-type: none"> • eĚPvc, tk>`tKvY, eĚ`tkvY, eĚ Ašlj ĭLZ PZFR • eĚ m`umkZ Dccv` <ul style="list-style-type: none"> ○ eĚĚi GKB Pvtci Dci `Ěvqgvb eĚv`tkvY tk>`tKvYi Ašlj ĭLZ PZFRi th`KvYi mgv`B m`ecixZ tkvYi mgv`B mgtkvY ○ eĚĚi GKB Pvtci Dci `Ěvqgvb eĚv`tkvY,tj v ci`ui mgv`B AaĚ`tkvY GK mgtkvY ○ eĚĚ Ašlj ĭLZ PZFRi th`KvYi mgv`B m`ecixZ tkvYi mgv`B mgtkvY ○ tkvY PZFRi th`KvYi mgv`B m`ecixZ tkvY m`uik ntj Zvi kvle`y PviU mgeĚ nte ○ eĚĚi th`KvYi mgv`B m`ecixZ tkvYi mgv`B m`ecixZ tkvYi mgv`B mgtkvY ○ eĚĚi evnt`tkvYi mgv`B m`ecixZ tkvYi mgv`B m`ecixZ tkvYi mgv`B mgtkvY 	<ul style="list-style-type: none"> • eĚ I eĚ`PZFR Ašlj ĭLZ PZFRi th`KvYi mgv`B m`ecixZ tkvYi mgv`B mgtkvY • R`vqvZK vpti`i gva`tg eĚ m`umkZ cġĚ Dccv` ,tj vi cġvY Dc`vcb 	 <ul style="list-style-type: none"> • cġĚ vpti` eĚPvc, tk>`tKvY, eĚ`tkvY I eĚ Ašlj ĭLZ PZFR kv`KiY • Dccv` ,tj vi cġvY m`vkvZv 	<ul style="list-style-type: none"> • vpti` I evL`vi gva`tg eĚPvc, tk>`tKvY, eĚ`tkvY, eĚ Ašlj ĭLZ PZFR evL`v KitZ cvite • eĚ m`umkZ Dccv` ,tj vi cġvY vKte

Αόγ Αα΄νq : eĚ (14 νcνi qW)

Pj gvb

νκLbdj	νελ qe΄	νκLb-τκLντν νbt` Rbv	gġ`νqb νbt` Rbv	νετκ I τj LK νbt` Rbv
<p>3. eĚ μαύμκζ μαύν` eYθν KiτZ cvite </p>	<ul style="list-style-type: none"> ○ `βu eĚ ci`ui`úk®Kiτj, Zντ`i τK>θq I`úk®>ymgtiL nte • eĚ μαύμκζ μαύν` <ul style="list-style-type: none"> ○ GKυU eĚ ev eĚPvc τ` I qv AvτQ, τK>`νbYθ KiτZ nte ○ eτĚi τKντν νe>`τZ GKυU`úk® AvκτZ nte ○ eτĚi ewnt`τKντν νe>`yt`τK eĚυUτZ`úk® AvκτZ nte ○ τKντν νbν`θ νi fτRi cνi eĚ AvκτZ nte ○ τKντν νbν`θ νi fτRi AśeĚ AvκτZ nte ○ τKντν νbν`θ νi fτRi ewneĚ AvκτZ nte 	<ul style="list-style-type: none"> • c0 Ě Z` I DcvτĚi νfνĚτZ eĚ μαύμκζ μαύν` τj vi A¼b I A¼τbi eYθν 	<ul style="list-style-type: none"> • μαύν` τj vi A¼τb μνVK avc AbνiY I A¼τbi h_ρ weeiY 	<ul style="list-style-type: none"> • eĚ μαύμκζ μαύν` τj vi A¼τbi eYθν _vKte

beg Aa`vq : wĭĭKvYvgnZK AbcvZ (16 vcvĭ qW)

wĭLbdj	vel qe`	wĭLb-ĭkLvĭbv vbt`Rbv	gj`vqb vbt`Rbv	vetkĭ tjLK vbt`Rbv																								
<p>eĭeĭxq</p> <p>1. m^zĭKvĭYi wĭĭKvYvgnZK AbcvZ eY^ĭ KĭĭZ cviĭte </p> <p>2. m^zĭKvĭYi wĭĭKvYvgnZK AbcvZ ,tj vi gĭa` cvi`uĭi K m^zuK^ĭ vY^ĭ KĭĭZ cviĭte </p>	<ul style="list-style-type: none"> m^zĭKvĭYi wĭĭKvYvgnZK AbcvZ ĭ Gĭ` i m^zuK^ĭ 	<ul style="list-style-type: none"> wĭĭ GĭK mgtKvYx wĭĭ fĭRi wewfbævüi AbcvZ ĭ_ĭK wĭĭKvYvgnZK AbcvZ vY^ĭ vel qK Avĭj vPbv wĭĭ^ĭ i GKKfvĭte vbt`Pi QKw cĭY <table border="1" data-bbox="898 602 1356 886"> <thead> <tr> <th data-bbox="898 602 1031 662">wĭĭKvYvgnZK AbcvZ</th> <th colspan="2" data-bbox="1031 602 1356 636">wĭĭKvYvgnZK AbcvZi msĭk^ĭ evü</th> </tr> <tr> <td></td> <th data-bbox="1031 662 1199 696">ce^ĭ wĭk (evü)</th> <th data-bbox="1199 662 1356 696">DĖi i wĭk (evü)</th> </tr> </thead> <tbody> <tr> <td data-bbox="898 696 1031 729">sine</td> <td data-bbox="1031 696 1199 729"></td> <td data-bbox="1199 696 1356 729"></td> </tr> <tr> <td data-bbox="898 729 1031 761">cosine</td> <td data-bbox="1031 729 1199 761"></td> <td data-bbox="1199 729 1356 761"></td> </tr> <tr> <td data-bbox="898 761 1031 794">tangent</td> <td data-bbox="1031 761 1199 794"></td> <td data-bbox="1199 761 1356 794"></td> </tr> <tr> <td data-bbox="898 794 1031 826">sec</td> <td data-bbox="1031 794 1199 826"></td> <td data-bbox="1199 794 1356 826"></td> </tr> <tr> <td data-bbox="898 826 1031 859">cosec</td> <td data-bbox="1031 826 1199 859"></td> <td data-bbox="1199 826 1356 859"></td> </tr> <tr> <td data-bbox="898 859 1031 891">cot</td> <td data-bbox="1031 859 1199 891"></td> <td data-bbox="1199 859 1356 891"></td> </tr> </tbody> </table> <p>Ges Gi gva`tg wĭĭKvYvgnZK AbcvZ ,tj vi cvi`uĭi K m^zuK^ĭ vY^ĭ </p>	wĭĭKvYvgnZK AbcvZ	wĭĭKvYvgnZK AbcvZi msĭk ^ĭ evü			ce ^ĭ wĭk (evü)	DĖi i wĭk (evü)	sine			cosine			tangent			sec			cosec			cot			<ul style="list-style-type: none"> QKcĭĭYi mgq vel qe`i mĭwKZv chĭeĭY 	<ul style="list-style-type: none"> m^zĭKvĭYi wĭĭKvYvgnZK AbcvZ mgtKvYx wĭĭ fĭRi mĭrvĭth` msAĭwqZ ntZ nĭte m`k wĭĭ fĭRi mĭrvĭth` AbcvZ ,tj vi aĭZv hvPvB _vKĭte R`vgnZK c^zĭZ AbcvZ ,tj vi cvi`uĭi K m^zuK^ĭ ĭ`LvĭZ nĭte
wĭĭKvYvgnZK AbcvZ	wĭĭKvYvgnZK AbcvZi msĭk ^ĭ evü																											
	ce ^ĭ wĭk (evü)	DĖi i wĭk (evü)																										
sine																												
cosine																												
tangent																												
sec																												
cosec																												
cot																												

beg Aa'vq : wĭ tKvYugwZK AbcvZ (16 wci qW)

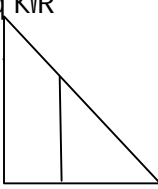
wLbdj	vel qe'	wLb-tkLvfbv wbt` Rbv	gj`vqb wbt` Rbv	we'ki tj LK wbt` Rbv																																																																													
<p>3. mZtKvYi wĭ tKvYugwZK AbcvZ ,tj vi aPZv hvPvB Kti cĉvY I MwYwZK mgm'v mgravb Ki tZ cvi te </p>	<ul style="list-style-type: none"> • 30°, 45°, 60° tKvYi wĭ tKvYugwZK AbcvZ 	<ul style="list-style-type: none"> • GKB tKvYi Rb" mg tKvY wĭ f tRi wewfba cwi gvtci evu wbtq AbcvZ ,tj vi aPZv hvPvB msµv` I Avtj vPbv <p>tRvoiq KvR</p>  <table border="1" data-bbox="829 665 1270 901"> <thead> <tr> <th></th> <th colspan="2">j µ^</th> <th colspan="2">AwZfR</th> <th colspan="2">fug</th> </tr> <tr> <th></th> <th>tmig</th> <th>tmig</th> <th>tmig</th> <th>tmig</th> <th>tmig</th> <th>tmig</th> </tr> </thead> <tbody> <tr> <td>sine 45°</td> <td></td> <td></td> <td></td> <td></td> <td></td> <td></td> </tr> <tr> <td>cos 45°</td> <td></td> <td></td> <td></td> <td></td> <td></td> <td></td> </tr> <tr> <td>tan 45°</td> <td></td> <td></td> <td></td> <td></td> <td></td> <td></td> </tr> </tbody> </table>		j µ^		AwZfR		fug			tmig	tmig	tmig	tmig	tmig	tmig	sine 45°							cos 45°							tan 45°							<ul style="list-style-type: none"> • tRvoiq KvRi mgq chfeyY I ckæDEi • MwYwZK mgm'vi tKvY Avf'v <ul style="list-style-type: none"> • ewoi KvR (QK ciY) <table border="1" data-bbox="1365 730 1722 941"> <thead> <tr> <th></th> <th>0°</th> <th>30°</th> <th>45°</th> <th>60°</th> <th>90°</th> </tr> </thead> <tbody> <tr> <td>sin</td> <td></td> <td></td> <td></td> <td></td> <td></td> </tr> <tr> <td>cos</td> <td></td> <td></td> <td></td> <td></td> <td></td> </tr> <tr> <td>tan</td> <td></td> <td></td> <td></td> <td></td> <td></td> </tr> <tr> <td>cosec</td> <td></td> <td></td> <td></td> <td></td> <td></td> </tr> <tr> <td>sec</td> <td></td> <td></td> <td></td> <td></td> <td></td> </tr> <tr> <td>cot</td> <td></td> <td></td> <td></td> <td></td> <td></td> </tr> </tbody> </table>		0°	30°	45°	60°	90°	sin						cos						tan						cosec						sec						cot						<ul style="list-style-type: none"> • sine, cosine I tangent Gi EaY'el wvµxgv wvY'el _vKte
	j µ^		AwZfR		fug																																																																												
	tmig	tmig	tmig	tmig	tmig	tmig																																																																											
sine 45°																																																																																	
cos 45°																																																																																	
tan 45°																																																																																	
	0°	30°	45°	60°	90°																																																																												
sin																																																																																	
cos																																																																																	
tan																																																																																	
cosec																																																																																	
sec																																																																																	
cot																																																																																	
<p>4. R'wguZK c×wZtZ 30°, 45°, 60° tKvYi wĭ tKvYugwZK AbcvZi gvb wvY'el I cĉqM Ki tZ cvi te </p>		<ul style="list-style-type: none"> • R'wguZK c×wZtZ 30°, 45°, 60° tKvYi wĭ tKvYugwZK AbcvZ wvY'el msµv` I Avtj vPbv 		<ul style="list-style-type: none"> • R'wguZK c×wZtZ 30°, 45°, 60° tKvYi wĭ tKvYugwZK AbcvZi gvb wvY'el _vKte 																																																																													
<p>5. 0° I 90° tKvYi A_ey° wĭ tKvYugwZK AbcvZ ,tj vi gvb wvY'el Kti cĉqM Ki tZ cvi te </p>	<ul style="list-style-type: none"> • 0° I 90° tKvYi wĭ tKvYugwZK AbcvZ 	<ul style="list-style-type: none"> • GKK KvR:(QK ciY) <table border="1" data-bbox="829 1096 1249 1291"> <thead> <tr> <th></th> <th>0°</th> <th>30°</th> <th>45°</th> <th>60°</th> <th>90°</th> </tr> </thead> <tbody> <tr> <td></td> <td>0</td> <td>1</td> <td>2</td> <td>3</td> <td>4</td> </tr> <tr> <td></td> <td>0/4</td> <td>1/4</td> <td>2/4</td> <td>3/4</td> <td>4/4</td> </tr> <tr> <td>sin</td> <td></td> <td></td> <td></td> <td></td> <td></td> </tr> <tr> <td>cos</td> <td></td> <td></td> <td></td> <td></td> <td></td> </tr> <tr> <td>tan</td> <td></td> <td></td> <td></td> <td></td> <td></td> </tr> </tbody> </table>		0°	30°	45°	60°	90°		0	1	2	3	4		0/4	1/4	2/4	3/4	4/4	sin						cos						tan						<ul style="list-style-type: none"> • tk'vYi KvR chfeyY 	<ul style="list-style-type: none"> • R'wguZK c×wZtZ 0° I 90° tKvYi A_ey° AbcvZ ,tj vi gvb wvY'el _vKte • gvb ,tj v Zvuj Kv AvKv'i I mn tR gtb ivLvi tKŠktj i eY'el _vKte 																																									
	0°	30°	45°	60°	90°																																																																												
	0	1	2	3	4																																																																												
	0/4	1/4	2/4	3/4	4/4																																																																												
sin																																																																																	
cos																																																																																	
tan																																																																																	

kg Aa'vq : 'iZjI D'PZv (10 ucuiqW)

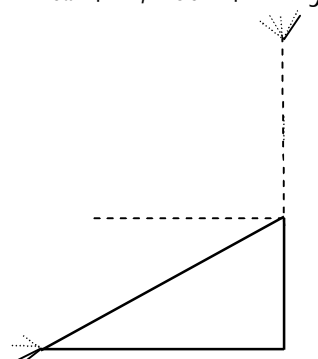
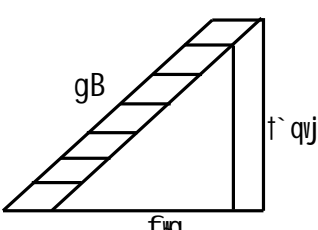
ukLbdj	vel qe'	ukLb-ikLvfbv vbi' Rbv	gj'vqb vbi' Rbv	vetki tj LK vbi' Rbv
<p>eyxeExq</p> <p>1. f-iLv, EaYfiLv, Ej #Zj, DbwZ tkvY I AebwZ tkvY e'vL'v KiZ cvi te </p> <p>2. w'itkvYugwzi mrvth' 'iZjI D'PZv vel qK MwYwZK mgm'v mgravb KiZ cvi te </p> <p>gibv'cwkR</p> <p>3. w'itkvYugwzi mrvth' nvtZ-Kj tg 'iZjI D'PZv vel qK w'efbocwi gvc KiZ cvi te </p>	<ul style="list-style-type: none"> f-iLv, EaYfiLv, Dj #Zj, DbwZ tkvY I AebwZ tkvY 'iZjI D'PZv vel qK mgm'v 	<ul style="list-style-type: none"> w'itkvY mrvth' f-iLv, Dj #Zj, DbwZ tkvY I AebwZ tkvY e'vL'v D'vni'Yi mrvth' 'iZjI D'PZv vel qK MwYwZK mgm'vi mgravb ev'bwfiEK 'iZjI D'PZv I DbwZ tkvY w'Yq 	<ul style="list-style-type: none"> w'itkvY w'itkvY f-iLv, Dj #Zj, DbwZ tkvY, AebwZ tkvY w'YwZKiY c0E mgm'v mgravb 'j xq kvR : 'iZjI D'PZv I DbwZ tkvY w'Yq  	<ul style="list-style-type: none"> w'itkvY mrvth' f-iLv, EaYfiLv, Dj #Zj, DbwZ tkvY I AebwZ tkvY e'vL'v vKte ev'bwfiEK mrvth' w'YwZKiY thb f-iLv, EaYfiLv, Dj #Zj, DbwZ tkvY I AebwZ tkvY e'vL'v KiZ cvi tmRb' c0qvRbxq I chw' kvh'ug Ašif' KiZ nte 'iZjI D'PZv vel qK MwYwZK mgm'vi cwkrcwk ev'bwfiEK mgm'v nvtZKj tg Kivi Dc'th'w' c0qvRbxq kvh'ug Ašif' KiZ nte

GKv` k Aa`vq : exRMWZxq AbjvZ I mgvbcvZ (12 wcvl qW)

wklbdj	we l qe`	wklb-fkLvfbv vbt` Rbv	gj`vqb vbt` Rbv	wetkl tj LK vbt` Rbv						
<p>expeEiq</p> <p>1. exRMWZxq AbjvZ I mgvbcvZ e`vL`v KiZ cvite </p> <p>2. mgvbcvZ mspvsi weifbe ifvsi wea c0qM KiZ cvite </p> <p>3. avivewK AbjvZ eY0v KiZ cvite </p> <p>4. ev`e mgm`v mgvavb AbjvZ, mgvbcvZ I avivewK AbjvZ e`envi KiZ cvite </p>	<ul style="list-style-type: none"> • exRMWZxq AbjvZ I mgvbcvZ • mgvbcvZi ifvsi wea • avivewK AbjvZ • ev`e mgm`v 	<ul style="list-style-type: none"> • D`vniYi mvinth` ewRMWZxq AbjvZ I mgvbcvZi e`vL`v • mgvbcvZi weifbwe ifvsi wea D`vniYi mvinth` Dc`vcb • D`vniYi gva`tg avivewK AbjvZi e`vL`v • AbjvZ, mgvbcvZ I avivewK AbjvZi mvinth` ev`e mgm`v mgvavb 	<ul style="list-style-type: none"> • exRMWZxq AbjvZ I mgvbcvZ wby0 <table border="1" data-bbox="1289 410 1591 565"> <thead> <tr> <th data-bbox="1289 410 1430 443">mgvbcvZ</th> <th data-bbox="1430 410 1591 443">ifvsi</th> </tr> </thead> <tbody> <tr> <td data-bbox="1289 443 1430 492">$\frac{a}{b} = \frac{c}{b}$</td> <td data-bbox="1430 443 1591 492">$\frac{a+b}{b} = \frac{c+d}{d}$</td> </tr> <tr> <td data-bbox="1289 492 1430 565"></td> <td data-bbox="1430 492 1591 565">i.) ii.) iii.)</td> </tr> </tbody> </table> <ul style="list-style-type: none"> • avivewK AbjvZ wby0 • AbjvZ mspvsi ev`e mgm`v mgvavb 	mgvbcvZ	ifvsi	$\frac{a}{b} = \frac{c}{b}$	$\frac{a+b}{b} = \frac{c+d}{d}$		i.) ii.) iii.)	<ul style="list-style-type: none"> • ev`ewfivEK D`vniYi gva`tg AbjvZ I mgvbcvZi Avtj vPbv _vKte c0hr` tytI e`vL`vgj K wPI msthvRb KiZ nte • mgvbcvZi ifvsi wea _tjvi c0vY _vKte • mnR t`tk RuUj Zi D`vniYi gva`tg ifvsi wea _tjvi c0qM _vKte • ev`e D`vniYi gva`tg avivewK AbjvZi Avtj vPbv _vKte c0hr` tytI e`vL`vgj K wPI msthvRb KiZ nte • MwYwZK mgm`v msej Z Abkxj bx _vKte
mgvbcvZ	ifvsi									
$\frac{a}{b} = \frac{c}{b}$	$\frac{a+b}{b} = \frac{c+d}{d}$									
	i.) ii.) iii.)									

Øv`k Aa`vq : `ß Pj Kuewkó mij mnmgxKiY (20 vciwqW)

wklbdj	vel qe`	wklb-tkLvfbv vbt` Rbv	gj`vqb vbt` Rbv	vetkl tj LK vbt` Rbv
<p>ey`eExq</p> <p>1. `ß Pj Kuewkó mij mnmgxKiYi m½wZ hvPvB KiZ cvi te </p> <p>2. `ß Pj Kuewkó `ßwU mgxKiYi ci`úi wbfPkxj Zv hvPvB KiZ cvi te </p> <p>3. Avo`Yb cxwZ e`vL`v KiZ cvi te </p> <p>4. ev`ewfwiEK mgm`vtK mgxKiYi mvrwth` mgvavb KiZ cvi te </p> <p>gtbvt`cwkR</p> <p>5. mij mnmgxKiYi mgvavb tj LwPt`T` LvZ cvi te </p> <p>6. tj LwPt`T`i mvrwth` `ß Pj Kuewkó `ßwU mij mnmgxKiY mgvavb KiZ cvi te </p> <p>Av`felMq</p> <p>7. MwYwZK mgm`vi mij mnmgxKiY MVb I mgvavtb AvMbx nte </p>	<ul style="list-style-type: none"> • `ß Pj Kuewkó mij mnmgxKiY • Avo`Yb cxwZ • mgvavb • tj LwPt`T`i mvrwth` mgvavb • ev`ewfwiEK mgm`v 	<ul style="list-style-type: none"> • D`vniYi mvrwth` `ß Pj Kuewkó mij mnmgxKiYi m½wZi kZewj Dc`vcb • `ß Pj Kuewkó `ßwU mgxKiYi ci`úi wbfPkxj Zv D`vniYi gva`tg Dc`vcb • D`vniYi gva`tg Avo`Yb cxwZi e`vL`v Dc`vcb • D`vniYi gva`tg ev`ewfwiEK mgm`vi mij mnmgxKiY MVb I mgvavb Dc`vcb • mij mnmgxKiYi mgvavb tj LwPt`T` Dc`vcb • tj LwPt`T`i mvrwth` `ß Pj Kuewkó `ßwU mij mnmgxKiYi mgvavb tKSkj Dc`vcb 	<ul style="list-style-type: none"> • `ß Pj Kuewkó mij mnmgxKiYi m½wZi kZewj wj Lb • `ß Pj Kuewkó `ßwU mij mnmgxKiY ci`úi wbfPkxj Zv hvPvB • Avo`Yb gva`tg mij mnmgxKiYi mgvavb • mij mnmgxKiY MVb I mgvavb • mij mnmgxKiYi tj LwPt`T` A½b • tj LwPt`T`i mvrwth` mgvavb 	<ul style="list-style-type: none"> • `ß Pj Kuewkó mij mnmgxKiYi avi Yv e`vL`v mn D`vniY`vKte • `ß Pj Kuewkó mij mnmgxKiY m½wZi kZewj D`vniYi mvrwth` e`vL`v`vKte • `ß Pj Kuewkó mij mnmgxKiY ci`úi wbfPkxj Zv D`vniYi mvrwth` hvPvB`vKte • Avo`Yb cxwZi mvrwth` mij mnmgxKiYi mgvavb tKSkj I MVb c½uqv D`vni Ymn`vKte • ev`ewfwiEK mgm`v mij mnmgxKiYi MVb I mgvavb D`vniY`vKte • tj LwPt`T`i mvrwth` `ß Pj Kuewkó mij mnmgxKiYi mgvavb tKSkjtji eYw`v`vKte • chwß D`vniY I Abkxj bx`vKte

Ĥġv`k Aa`vq : mmxg aviv

(12 vcv qW)

wLbdj	vel qe`	wLb-ĤkLvġbv vbt`Rbv	gġ`vqb vbt`Rbv	weĤkI tj LK vbt`Rbv								
<p>ex`eĤxq</p> <ol style="list-style-type: none"> 1. Abġug I aviv eYġv KiĤZ I Zvġ`i cv`R` vbiġcY KiĤZ cviġe 2. mġvŠli aviv e`vL`v KiĤZ cviġe 3. mġvŠli avivi vbw`ġZg c` I vbw`ġ msL`K cġ`i mġwó vbyġqi mġ MVb KiĤZ cviġe Ges mġ cġqvM Kġi MwywZK mġm`v mġvavb KiĤZ cviġe 4. ġvfwek msL`vi eġMP I Nġbi mġwó vbyġġ KiĤZ cviġe 5. avivi vewfbumġ cġqvM Kġi MwywZK mġm`vi mġvavb KiĤZ cviġe 6. ġYvĤi avivi vbw`ġZg c` I vbw`ġ msL`K cġ`i mġwó vbyġqi mġ MVb KiĤZ cviġe Ges mġ cġqvM Kġi MwywZK mġm`vi mġvavb KiĤZ cviġe <p>AvġeMxq</p> <ol style="list-style-type: none"> 7. mġm`v mġvavtbi Rb` mġvŠli I ġYvĤi aviv MVġb AvMġbx nġe 	<ul style="list-style-type: none"> • Abġug I aviv • mġvŠli aviv <ul style="list-style-type: none"> o mġvŠli avivi vbw`ġZg c` o vbw`ġ msL`K cġ`i mġwó • mmxg ġvfwek msL`vi mġwó <ul style="list-style-type: none"> o weĤkI msL`vi mġwó o tRvo msL`vi mġwó o eġMP mġwó o ġYvĤi mġwó • ġYvĤi aviv • MwywZK mġm`v 	<ul style="list-style-type: none"> • D`vniġYi mġvntġh` Abġug I avivi e`vL`v • mmxg I Amxg avivi aviYv • D`vniġYi mġvntġh` mmxg mġvŠli avivi e`vL`v Ges vbw`ġ c` I cġ`i mġwó vbyġqi mġ • cġg n msL`K weġRvo Ges tRvo msL`vi mġwó vbyġqi mġ cġZcv`b • weĤkI Y cġqvq cġg n msL`K ġvfwek msL`vi eM`Ges Nġbi mġwó vbyġqi mġ • D`vniġYi mġvntġh` mmxg ġYvĤi avivi e`vL`v Ges vbw`ġ c` I vbw`ġ msL`K cġ`i mġwó vbtYġ mġ 	<ul style="list-style-type: none"> • QK cġY : Abġug/mmxg aviv /Amxg aviv <table border="1" data-bbox="1360 410 1635 532"> <tr> <td>1+4+6+.....+50</td> <td></td> </tr> <tr> <td>5,10,15.....</td> <td></td> </tr> <tr> <td>3+6+9.....</td> <td></td> </tr> <tr> <td>BZ`vġ</td> <td></td> </tr> </table> <ul style="list-style-type: none"> • vbw`ġ c` I cġ`i mġwó vbyġġ • ġvfwek msL`vi eM` Nġbi mġwó vbyġġ • ġYvĤi avivi vbw`ġ c` I vbw`ġ msL`K cġ`i mġwó vbyġġ 	1+4+6+.....+50		5,10,15.....		3+6+9.....		BZ`vġ		<ul style="list-style-type: none"> • Abġug I avivi eYġv I cv`R` vKġe • D`vniYm n mmxg avivi e`vL`v vKġe • mġvŠli avivi vbw`ġZg c` I vbw`ġ msL`K cġ`i mġwó vbyġqi mġġi e`vL`v I D`vniY vKġe mġvŠli avivi mġwó mġġi mġvntġh` cġg n msL`K ġvfwek msL`vi mġwó, weġRvo ġvfwek msL`vi mġwó I tRvo ġvfwek msL`vi mġwó vbyġqi e`vL`v vKġe • cġg n msL`K ġvfwek msL`vi eġMP mġwó I Nġbi mġwó vbyġqi e`vL`v vKġe Ges eM` Nġbi mġwó mġġi cġqvM I D`vniY vKġe • ġYvĤi avivi vbw`ġZg I vbw`ġ msL`K cġ`i mġwó vbyġqi mġġi e`vL`v vKġe I D`vniY vKġe • chġB D`vniY I Abġxj bx vKġe
1+4+6+.....+50												
5,10,15.....												
3+6+9.....												
BZ`vġ												

PZi R Aa`vq : AbcvZ,m`kZv I cZmgZv (20 ucvi qW)

wklbdj	weiqe`	wklb-iklvbv vbt` Rbv	gj`vqb vbt` Rbv	vetkl tj LK vbt` Rbv
<p>expe`vq</p> <ol style="list-style-type: none"> 1. R`wgnZK AbcvZ m`utK^o e`vL`v KitZ cvite 2. tiLvtki AsteFw³ e`vL`v KitZ cvite 3. AbcvZ m`umKZ Dccv` ,tj v hvPvB I cgvY KitZ cvite 4. m`kZvi AbcvZ mspvsl Dccv` ,tj v hvPvB I cgvY KitZ cvite 	<ul style="list-style-type: none"> • AbcvZ • tiLvtki AsteFw³ • AbcvZ m`umKZ Dccv` <ul style="list-style-type: none"> ○ wlfRi thtKvrbv evui mgvsliv mij tiLv H wlfRi Aci evu0qtK ev Zvt` i evaZvsk0qtK mgvb AbcvZ wef³ Kti ○ thtKvrbv mij tiLv GKwU wlfRi `BvutK ev Zvt` i evaZvsk0qtK mgvb AbcvZ wef³ Kiti ,D³ tiLv wlfRwI ZZxq evui mgvsliv ○ wlfRi thtKvrbv thtKvYi AsteEeK wecixZ evutK D³ thtKvY msj Mævut0tqi AbcvZ AsteF³ Kti ○ `BwU wlfR m`kKvYx ntj Zvt` i Abjfc evu ,tj v mgvbcwZK nte ○ `BwU wlfRi evu ,tj v mgvbcwZK ntj Abjfc evui wecixZ thtKvY ,tj v ci`ui mgvb nte ○ `BwU wlfRi GKwI GK thtKvY Aci GKwU wlfRi GK thtKvYi mgvb ntj Ges Zvt` i thtKvYmsj Mæ evu ,tj v mgvbcwZK ntj , wlfR0q m`k nte ○ `BwU m`k wlfRtytI i tyIdj 0tqi AbcvZ Zvt` i thtKvrbv `B Abjfc evui Dci AwZ eMtytI i tyIdj 0tqi AbcvZi mgvb 	<ul style="list-style-type: none"> • R`wgnZK wPtI i gva`tg R`wgnZK AbcvZ I tiLvtki AsteFw³ i e`vL`v • wPtI i gva`tg AbcvZ I m`kZvi AbcvZ m`umKZ Dccv` hvPvB I cgvY Dc`rcb 	<ul style="list-style-type: none"> • wPtI t`tk R`wgnZK AbcvZ I AsteFw³ i wYq • c0E Dccv` ,tj v cgvY 	<ul style="list-style-type: none"> • R`wgnZK AbcvZ m`utK^o wPtI e`vL`v _vKte • tiLvtki AsteFw³ wPtI mvrth` _vKte • AbcvZ m`umKZ Dccv` ,tj v hvPvB Kivi c0qvRbxq Kvh0g I cgvY _vKte

PZi R Aa'vq : AbcvZ,m`kZv I cZmgZv (20 vciqW)

Pj gvb 2

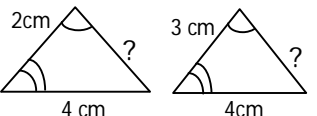
vklbdj	vel qe''	vklb-iklvbv vbt`Rbv	gv`vqb vbt`Rbv	vetki tj LK vbt`Rbv
<p>eyxeE'vq</p> <p>5. cZmgZvi aviYv e'vL'v KiZ cvite </p> <p>6. nvZ-Kj tg ev'e DcKiYi mrvth' tiLv I NYB cZmgZv hvPvB KiZ cvite </p> <p>gtbt'cukR</p> <p>7. AbcvZ I m`kZvi aviYv e'envi Kti N'cwigvc KiZ cvite </p>	<ul style="list-style-type: none"> cZmgZv tiLv I NYB cZmgZv AbcvZ I m`kZvi aviYv e'envi Kti cwigvc 	<ul style="list-style-type: none"> ev'e DcKiYi mrvth' cZmgZv I NYB cZmgZv hvPvBqi Avtj vPbv AbcvZ I m`kZvi aviYv e'envi Kti N'cwigvc e'vL'v 	<ul style="list-style-type: none"> ev'e DcKiYi mrvth' cZmgZv I NYB cZmgZv hvPvB cE wif'ri ARvbv evui N'wbyq 	<ul style="list-style-type: none"> ev'e D'vniY I wP'i mrvth' cZmgZvi e'vL'v vKte nvZ-Kj tg ev'e DcKiYi mrvth' tiLv I NYB cZmgZv hvPvB Kivi c'qvRbxq Kvhp'g ASif' AbcvZ I m`kZvi aviYv e'envi Kti N'cwigvc Kvhp'g vKte

cĀ`k Aa`vq : tÿĪdj m̄uĪKZ Dccv` I m̄uĪ` (12 vci qW)

wLbdj	vel qe`	wLb-ĵkLvĵv vĵ` Rbv	gĵ`vq vĵ` Rbv	veĵkĪ ĵj LK vĵ` Rbv
<p>ep̄xeĒvq</p> <p>1. eufRtÿĪi tÿĪdtj i avi Yv e`vL`v KiĵZ cviĵe </p> <p>2. tÿĪdj m̄p̄všĪDccv` hvPvB I cġvY KiĵZ cviĵe </p> <p>3. c`Ē DcvĒ e`envi Kĵi eufR tÿĪ A%b I A%ĵbi h_P_Zv hvPvB KiĵZ cviĵe </p> <p>gĵvĵcĵkR</p> <p>4. wĪfRtÿĪi tÿĪdtj i mgvb PZfRtÿĪ A%b KiĵZ cviĵe </p> <p>5. PZfRtÿĪi tÿĪdtj i mgvb wĪfRtÿĪ A%b KiĵZ cviĵe </p> <p>6. wewfbacĵvi R`wġvZK-Kwi Mwi wPĪ A%b KiĵZ cviĵe </p>	<ul style="list-style-type: none"> • eufRtÿĪi tÿĪdj • tÿĪdj m̄p̄všĪDccv` hvPvB I cġvY <ul style="list-style-type: none"> o GKB fġgi Dci Ges GKB mgvšĪĵj tiLvĵĵi gĵa` Aew`Z mKj wĪfRtÿĪi tÿĪdj mgvb o GKB fġgi Dci Ges GKB mgvšĪĵj tiLvĵĵi gĵa` Aew`Z mgvšĪĵi KtÿĪmgĵni tÿĪdj mgvb • tÿĪdj m̄p̄všĪm̄uĪ` <ul style="list-style-type: none"> o Ggb GKwU wĪfR AvKĵZ nĵe hv ōviv mgve× tÿĪi tÿĪdj GKwU vĵv` ō PZfRtÿĪi tÿĪdtj i mgvb nq o GKwU wĪfRtÿĪi tÿĪdtj i mgvb tÿĪdj wewkó GKwU mgvšĪĵi K AvkĵZ nĵe, hvi GKwU tKvY GKwU vĵv` ō tKvYi mgvb nq o GKwU PZfRtÿĪi tÿĪdtj i mgvb tÿĪdj wewkó GKwU mgvšĪĵi K AvkĵZ nĵe, hvi GKwU tKvY GKwU vĵv` ō tKvYi mgvb nq • wewfbacĵvi R`wġvZK-Kwi Mwi wPĪ A%b 	<ul style="list-style-type: none"> • R`wġvZK wPĪ I ev`Ē D`vniĵYi gĵa`g eufR tÿĪi tÿĪdtj i avi Yv Dc`vcb • R`wġvZK wPĪi gĵa`g tÿĪdj m̄p̄všĪcĒĒ Dccv`i hvPvB I cġvY Dc`vcb • cĒĒ Z` I DcvĒ e`envi Kĵi eufR tÿĪ A%b I A%ĵbi wewiY Dc`vcb • cĒkĒĒi gĵa`g wewfbacĵvi R`wġvZK Kwi Mwi wPĪ A%ĵbi wewiY Dc`vcb 	<ul style="list-style-type: none"> • eufR tÿĪi tÿĪdj eYĵv • cĒĒ Dccv`ĵj vi m̄wK hvPvBKĪY I cġvY • m̄wKfĵte eufR tÿĪ A%b • wewfbacĵvi DcvĒ e`envi Kĵi R`wġvZK Kwi Mwi wPĪ A%b 	<ul style="list-style-type: none"> • wPĪ I ev`Ē D`vniĵYi m̄vntĵ` eufRtÿĪi tÿĪdtj i avi Yvi e`vL`v_vKĵe • tÿĪdj m̄p̄všĪ Dccv`ĵj v hvPvB Kivi cĒq̄vRbxq Kvhġg I Dccv` cġvY_vKĵe • c`Ē Z` I DcvĒ e`envi Kĵi tÿĪdj m̄p̄všĪA%b_vKĵe • wewfbacĵvi DcvĒ e`envi Kĵi R`wġvZK-Kwi Mwi wPĪ A%b DcĵhvMx Kvhġg AšfĒ_vKĵe

Iô`k Aa`vq : cwiqvuz (22 ucwiqW)

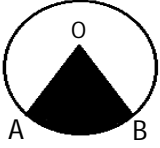
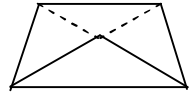
wkLbdj	vel qe`	wkLb-ikLvrbv vbt` Rbv	gj`vqb vbt` Rbv	wetkl tj LK vbt` Rbv									
<p>ep`eE`vq</p> <p>1. wí fRtýl I PZfRtýtl i tyldj i mî c0qM Kti eufRtýtl i tyldj wbyq Ges GZ` m=umKZ mgm'v mgravb KitZ cvi te </p> <p>2. eEi cwiva I eEistki ^^N° wbyq KitZ cvi te </p> <p>3. eEi tyldj wbyq KitZ cvi te </p> <p>4. eEtyl I Zvi Askwetkli tyldj wbyq Kti GZ` m=umKZ mgm'v mgravb KitZ cvi te </p> <p>5. AvqZvKvi Nbe` ; NbK I tej tbi tyldj cwigc KitZ cvi te Ges G m=umKZ mgm'v mgravb KitZ cvi te </p> <p>gtbrtcwr</p> <p>6. mlg I Amg AvKvti i eufRtýtl i tyldj cwigc KitZ cvi te </p>	<ul style="list-style-type: none"> tyldj wbyq <ul style="list-style-type: none"> wí fRtýl, AvqZtyl, eMtyl I i=htyl, mvgvshl Ktyl, UhwRqvgtyl I eufRtýl eE mspvsl cwigc <ul style="list-style-type: none"> eEi cwiva I eEistki ^^N° eEtyl I Zvi Askwetkli tyldj wewfbre Nbe` i AvqZb <ul style="list-style-type: none"> AvqZvKvi Nbe` ; NbK I tej b mlg I Amg AvKvti i eufRtýl 	<ul style="list-style-type: none"> c0kEti i gva`tg wí fRtýl I PZfRtýtl i tyldj wbyq i mî eYb mî c0qM Kti eufR tytl i tyldj wbyq i weeiY Avtj vPbv DcKityl i gva`tg eEi cwiva I eEistki ^^N° wbyq i Avtj vPbv eEi tyldj wbyq i mî i eYb Dc`vcb mî c0qM Kti eEi tyldj wbyq i eYb R`wqWZK vPtI i gva`tg eEi Ask wetkli tyldj wbyq i eYb Dc`vcb eEi Ask wetkli tyldj wbyq m=umKZ mgm'v mgravb Dc`vcb er`b DcKityl i gva`tg AvqZvKvi Nbe` ; NbK I tej tbi tyldj wbyq i mî i eYb Dc`vcb mî c0qM i gva`tg c0E DcKityl tyldj wbyq Ges G mspvsl mgm'v mgravb Dc`vcb mlg I Amg AvKvti i eufR tytl i tyldj wbyq Dc`vcb 	<p>QK ciY : (ewoi KvR)</p> <ul style="list-style-type: none"> c0E tytl i tyldj wbyq <table border="1" data-bbox="1375 406 1659 527"> <tr> <td>tyl</td> <td>vP</td> <td>tyldj</td> </tr> <tr> <td>wí fR</td> <td></td> <td></td> </tr> <tr> <td>PZfR</td> <td></td> <td></td> </tr> </table> <ul style="list-style-type: none"> c0E eEi cwiva I eEistki ^^N° wbyq eEi tyldj wbyq c0E eEi Ask wetkli i tyldj wbyq  <ul style="list-style-type: none"> c0E Amg AvKvti i eufR tytl i tyldj wbyq 	tyl	vP	tyldj	wí fR			PZfR			<ul style="list-style-type: none"> wí fRtýl I PZfRtýtl i tyldj i mî c0qM Kti eufRtýtl i tyldj wbyq i eYb vKte Ges GZ` m=umKZ mgm'v mgravb KitZ cvi i Dchjv Kvhpeg vKte eEi cwiva I eEistki ^^N° wbyq i e`vL` vKte eEi tyldj wbyq i Kvhpeg vKte eEtyl I Zvi Askwetkli tyldj wbyq Kti GZ` m=umKZ mgm'v mgravb i Rb` c0qRbxq Kvhpeg vKte AvqZvKvi Nbe` ; NbK I tej tbi tyldj cwigc KitZ cvi te Ges G m=umKZ mgm'v mgravb Kivi Dc`hwMx KvR vKte mlg I Amg AvKvti i eufRtýtl i tyldj cwigc i eYb vKte Ges c0qRbxq Kvhpeg vKte
tyl	vP	tyldj											
wí fR													
PZfR													

mB`k Aa`vq : cwi msL`vb (12 ucwi qW)

wklbdj	vel qe`	wklb-iklvbv vbt`Rbv	gj`vqb vbt`Rbv	wetkl tj LK vbt`Rbv
<p>epxeExq</p> <p>1. tK`xq cEYZvi cwi gvc cxiZ e`vL`v Ki tZ cvi te </p> <p>2. tK`xq cEYZvi cwi gvtc msivB cxiZi cOqvRbxqZv e`vL`v Ki tZ cvi te </p> <p>3. msivB cxiZi mnvth` Mo, ga`K I cPi K vbYq Ki tZ cvi te </p> <p>4. μgthwRZ MYmsL`v, MYmsL`v eufR I AwRf ti Lv e`vL`v Ki tZ cvi te </p> <p>5. MYmsL`v eufR I AwRf ti Lv tj LwPtI mnvth` DcvE e`vL`v Ki tZ cvi te </p> <p>gtbv`cwkR</p> <p>6. μgthwRZ MYmsL`v e`envi Kti MYmsL`v eufR I AwRf ti Lv A%b Ki tZ cvi te </p> <p>7. Z` msMh I wetkl Y Kti tj LwPtI Dc`vcb Ki tZ cvi te </p>	<ul style="list-style-type: none"> • tK`xq cEYZvi <ul style="list-style-type: none"> ○ tK`xq cEYZvi cwi gvc ○ tK`xq cEYZvi cwi gvtc msivB cxiZi cOqvRbxqZv ○ msivB cxiZtZ Mo, ga`K I cPi K vbYq • weifbæitbi Z` wetkl Y, tj LwPtI Dc`vcb I e`vL`v • MYmsL`v eufR I AwRf ti Lv A%b 	<ul style="list-style-type: none"> • D`vni tYi mnvth` tK`xq cwi gvtc i e`vL`v Ges Mo, ga`K I cPi K vbYq cxiZ eYbv • D`vni tYi gva`tg μgthwRZ MYmsL`v, MYmsL`v eufRi e`vL`v Ges tj LwPtI t`tK DcvE wetkl Y • Z` msMhni gva`tg MYmsL`v eufR I AwRf ti Lv A%tbi e`vL`v 	<ul style="list-style-type: none"> • cO E Z` DcvE t`tK Mo, ga`K I cPi K vbYq • cO E Z` DcvE t`tK MYmsL`v eufR I AwRf ti Lv A%b I Z` wetkl Y 	<ul style="list-style-type: none"> • tK`xq cEYZvi cwi gvc, tj vi e`vL`v vKte • tK`xq cEYZvi cwi gvtc msivB cxiZi cOqvRbxqZv e`vL`v vKte • D`vni tYi gva`tg msivB cxiZtZ Mo, ga`K I cPi K vbYq cxiZi e`vL`v vKte • MYmsL`v vbt`ektbi mnvth` μgthwRZ MYmsL`v, MYmsL`v eufR I AwRf ti Lvi e`vL`v vKte • weifbæD`vni tYi mnvth` MYmsL`v eufR I AwRf ti Lv wKfvte DcvE tK e`vL`v Kti Zv vKte

5. tj LK wbt`Rbv

beg-`kg tk0Yi MNYZ welqW i Rb` 100 baf eiv` ivLv ntqtQ| mBvtn 4 wJ Kti 2 eQti tgvU 288 wJ wciwqW eiv` ivLv ntqtQ| c0ZwU wciwqW mgq 50 wgbU| MNYZ welqW wkyvutg wKLbdj Ges welqW`Ggbfvt e cVqb Kiv ntqtQ thb eiv` KZ 288 wciwqW wkyv_xPv me_tjv wKLbdj AR0 KiZ cvti | MNYZ welqW beg-`kg tk0Yi mKj kvLvi wkyv_xPv i Rb` GKwU Avenk`K welq| MNYZ welq GKwU cv`cyf`Ki mcwii k Kiv ntqtQ| cv`cyf`Ki mcwii kKZ c0vmsL`v ntjv (300±20)c0v|

cv`cyf`K i Pbv i tyf`i wbt`Rbv wLZ welqmgfni c0Z mietkl _iaZjw`tZ nte-

1. wkyvKtg ewYZ mjbw`0 wKLbdj Ges wKLb-tkLvtrv wbt`Rbv wetePbvq titL welqW`Dc`vcb KiZ nte|
2. c0hvr` tyf`i Aa0v`e ch0q welqW`Dc`vcb KiZ nte| Dc`vctbi iwZ nte mnR t`tK KwB, Rvtrv t`tK ARvtrv I gZ`t`tK wgz0 welqW`Dc`vctb avivewNKZv eRvq ivLtz nte Ges wkyv_xPv i eqm, gubimK cwi cKZv I aviY ygZv Dc`thvMx Kti mnR I Pwj Z fvlvq wj LtZ nte|
3. welqW`Dc`vctb c0hvr` D`vniY e`envi KiZ nte| c0Z Aa`vtq c0m0K I RxbwfvEK D`vniY cv`cyf`K msthvRb KiZ nte| Abkxj bxtZ Dc`wcz mgm`vmgn PPPQovl wkyv_xPv wPŠi I aviYvi thb weKvk NtU tmv`tK tLqj ivLtz nte| Dc`wcz D`vniY I Abkxj bxi KvRmgn wkyv_xPv i `bw`b Rxtbi Ges AvRZ AvfAZvi mv`_ Aek`B m0uK0 ntz nte|
4. AvteMxq wKLbdj AR0bi Rb` welqW`Dc`vctb ev`bwfvEK mgm`v I KgRvU msthvRb KiZ nte|
5. welqW`i Dc`vcb KgRvU wfvEK ntz nte| Dc`wcz welqW`AvKl0xq I Avb``vqK Kivi Dci _iaZjc0vb KiZ nte, hvfZ MNYZ wkyvi c0Z wkyv_xPv i Avtrv I fwiZ`t`nq|
6. wKLbdj AR0bi Rb` ch0B Abkxj bx`w`tz nte Ges Abkxj bxtZ mRbkxj c0k0 msthvRb KiZ nte|
7. wkyv_xPv epx`eExq weKvk mnvqK mgm`v msthvRb KiZ nte| wkyf`Ki b`bZg mnvqZvq hvfZ wkyv_xPv welqW`AvqE KiZ cvti th`w`tK Zxye`w`w`tz nte|
8. we`vj qwfvEK gj`vqfbi Dc`thvMx KgRvUwfvEK welqW` (activity based content) cv`cyf`K msthvRb KiZ nte|
9. welqW`Dc`vctb tR0vi mgZv (gender equity) i yv KiZ nte|
10. welqW`Dc`vcb `bwZK gj`tevtai cwi cšK I agv0 AbfvZtZ AvwZ nvtb Ggb welqW`cwi nvi KiZ nte|

rkývµg

D'PZi MwZ

beg-`kg tkö

1. fvgKv

gvbe mF`Zvi AMWZ mvaṭb weÁvṭbi Ae`vb Acwi mḡ | Avi weÁvṭbi Pwj Kv kw³ MmYZ | ZvB RvZxq wkývµtg mKj wkýv_x[®] Rb³ MmYZtK Avek`Kxq cv³ Kiv ntqtQ | Zte th tKvb weÁvb I ch³ wkývi Rb³ MmYZi AwaKZi gReZ Ávṭbi cḡqvRb | Avi GB Dfī k³ wbtqB D`PZi MmYZi hvīv |

wkýv_x[®] i tK MmYZ wkývq AvMḡx Kivi j tÿ³ D`PZi MmYZtK mnR mij I my`i frte Dc`vcb Kivi cḡvm tbi qv ntqtQ | weṭkī mF`Zv, weÁvb-ch³ GwMtg Pj tQ weavq MmYZtKI Zij ti tL Pj tZ nte | ZvB tek wKQz bZb weI qe` thgb: `vbv¼ R`wgvZ, wḡc`x we`jZ I m`fvebvi AeZvi Yv Kiv ntqtQ | D`PZi MmYZ h³ gj K R`wgvZi fvi j vNe Kti e`enwi K R`wgvZtK cḡarb³ t`I qv ntqtQ | cḡq cḡZtÿtī cḡtqmMK MmYZi Dci tRvi t`I qv ntqtQ |

wkýv_x[®] hv tZ ev`ewfivEK mgm`v mgvavṭb exRMmYZ I R`wgvZtK e`enwi KtZ cḡti tmm tK weṭki iZi Avṭivc Kiv ntqtQ | wkýv_x[®] i MmYZK h³ e`enwi Kivi thvM`Zv Ges wPŠīi cwi va weKv tki mṭhvM mḡoi gva tḡ D`PZi chḡq wkýv MḡtYi wFZ gReZ Kiv-D`PZi MmYZi Ab`Zg Dfī k³ |

2. Dfík

1. tmU I dsktbi m=úmwí Z Ávb jvf Kti c0qM KiZ civ |
2. `ß Pj Kwekó mgxKiY tRvUi mgvab wbY@ I c0qM mýg nI qv |
3. AmgZvi avi Yv jvf Kti GK I `ß Pj Kwekó AmgZvi mgvab Kiv Ges er`é týtÎ Zv c0qM KiZ mýg nI qv |
4. mPKxq I j Mwí `gxq dskb m=útk©avi Yv jvf Kiv Ges tj LwPÎ A¼tb mýg nI qv |
5. Amxg avivi Ávb jvf Kiv I Zv e`enfti mýg nI qv |
6. w0c`x we`hzi avi Yv jvf Kiv I MwYwZK mgm`v mgvartb mýg nI qv |
7. R`wguZK A¼b I Dccv` c0qY `ýZv AR@ Kiv |
8. `vbi¼ R`wguZi tgšij K avi Yv jvf Kiv I mij tili mgxKiY Mvb KiZ mýg nI qv |
9. mgZj xq tftiti avi Yv I c0qM m=útk©AeMZ nI qv |
10. wî gwi K e`i cwi gvc KiZ mýg nI qv |
11. wî tKvYwguZK Abcvfti Ávb m=ctwi Y Kiv I c0qM `ý nI qv |
12. m=ebvi c0wgK avi Yv jvf Kti c0qM mýg nI qv |
13. MwYtzi AvabK a`vb-avi Yv m=úKZ Ávb jvf Kti Ab`vb` weliqi mvt_ MwYtzi m=úK©ıcb Kiv |

3. Aa'vq web'vm I wciqW eEb

		Aa'vqi wktivbvg	wciqW	cbivtj vPbvi Rb' eiv' KZ wciqW
beg tkW-1g tmvg ÷ vi	1.	tmU I dvskb	12	4
	2.	exRMwYwZK iwkw	12	4
	3.	mgxKiY	14	5
	4.	R'wgiZ	10	3
	5.	wI tKvYwgiZ	6	2
			54	18
beg tkW-2q tmvg ÷ vi	1.	AmgZv	10	3
	2.	mPKxq I j Mwi `gxq dvskb	12	4
	3.	Amxg aviv	7	3
	4.	wOc `x we'wZ	7	2
	5.	R'wgiZK A¼b	12	4
	6.	wI tKvYwgiZ	6	2
			54	18
`kg tkW-1g tmvg ÷ vi	1.	`vbw¼ R'wgiZ	12	4
	2.	tf±i	10	3
	3.	Nb R'wgiZ	14	5
	4.	wI tKvYwgiZ	10	3
	5.	m=tebv	8	3
			54	18
`kg tkW-i 2q tmvg ÷ vi m=uy' mtj evtmi I ci wbePwb cixyv AbjwZ nq ZvB `kg tkW-i 2q tmvg ÷ vi eiv' KZ 54 wciqW m=uy' eBtqi cbivtj vPbvi Rb' eiv' ivLv nqtqQ 				

4. $\text{nk} \dot{\text{y}} \text{v} \mu \text{g} \text{QK}$
 $\text{beg} - \text{`kg tk} \ddot{\text{v}}$

c0g Aa`vq : tmu I dskb (12 ucniqW)

wLbdj	velqe`	wLb-tkLvfbv ibt` Rbv	gj`vqb ibt` Rbv	wetkl tj LK ibt` Rbv
<p>ey`eE`xq</p> <p>1. mwelR tmu, Dctmu, ciK tmu I kw³ tmu MVb KiZ cvi te </p> <p>2. wefbae tmtUi msthvM, tQ` I ASi wbyq KiZ cvi te </p> <p>3. tmu ctkqvi agfeyj i ths³K cgy KiZ cvi te </p> <p>4. mgZj tmu eYb KiZ cvi te Ges Gi gra`tg Amxg tmtUi avi Yv e`vL`v KiZ cvi te </p> <p>5. tmtUi msthvMi kw³ tmu wbyqi m` e`vL`v KiZ cvi te Ges tfbwP` I D`vniYi mvrth` Zv hvPvB KiZ cvi te </p> <p>6. tmu cuqv cuqM Kti RiebirFvEK mgm`v mgvavb KiZ cvi te </p>	<ul style="list-style-type: none"> • mwelR tmu, Dctmu, ciK tmu I kw³ tmu • tmtUi msthvM, tQ` I ASi • tmu ctkqvi agfeyj • mgZj tmu I Amxg tmu • tmtUi msthvMi kw³ tmu • ev`e mgm`v mgvavb tmu 	<ul style="list-style-type: none"> • GKK I `j MZ KvRi gra`tg mwelR tmu, Dctmu, ciK tmu I kw³ tmu MVb • D`vniYi mvrth` tmtUi msthvM weva, weibgg weva, `v gi M`v`bi m`T i e`vL`v I e`envi • D`vniYi gra`tg mgvb mSL`K Dcv`vb weiko `Bw tmtUi mvrth` mgZj tmu e`vL`v • `vfwek mSL`vi tmtUi mvrth` Amxg tmtUi e`vL`v Ges D³ tmtUi wefbae Dctmu I {1, 1/2, 2/3, 3/4,} Gi gra`tg Amxg mgZj tmtUi D`vniY • D`vniYi mvrth` kw³ tmtUi e`envi Dc`vcb 	<ul style="list-style-type: none"> • tmu MV`bi mwKZv • tmu ctkvk mwK wP`tyi e`envi • c`hvR` ty`T mwK m` wbePb • m`T i mvrth` h_v`Pvte mgvavb • `vfwek mSL`vi tmu t`K wefbae Amxg Dctmu `Zwi Kiv Ges G` i mgZj `Zv hvPvB • kw³ tmu MV`bi m`ygzv hvPvB 	<ul style="list-style-type: none"> • tmtUi msthvM weva, weibgg weva, `v gi M`v`bi m`

c0g Aa`vq : tmU I dskb (12 wciqW)

Pj gvb 2

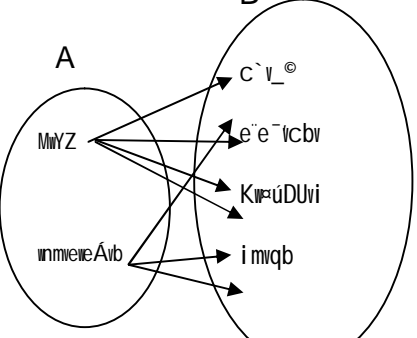
wLbdj	velqe`	wLb-tkLvfbv vbt` Rbv	gj`vqb vbt` Rbv	wekl tj LK vbt` Rbv
7. tmU i mrvth` Ašq I dskb Gi avi Yv e`vL`v KiZ cvi te	<ul style="list-style-type: none"> Ašq Ges dskb Gi avi Yv 	<ul style="list-style-type: none"> ev`e D`vni tYi gra`tg Ašq I dskbtK e`vL`v Kiv , thgb-fwZP c0K thM`Zv 	<ul style="list-style-type: none"> Ašq I dskb kbr`K i tYi mWkZv tWtgb I tiA wY`q i mWkZv 	<ul style="list-style-type: none"> cwi wPZ D`vni tYi gra`tg Ašq I dskbt i avi Yv Dc`vc b Kiv Ges mvt` mvt` tWtgb, tKvN tWtgb, ti tAi avi Yv Ges t f b w P t i Gi Dc`vc b _vK te
8. dsktbi tWtgb I tiA wY`q KiZ cvi te	<ul style="list-style-type: none"> dskb Gi tWtgb I tiA GK-GK dskb, mweR dskb I GK-GK mweR dskb 		<ul style="list-style-type: none"> GK-GK dskb mweR I GK-GK dskb kbr`K i tYi mWkZv 	<ul style="list-style-type: none"> dsktbi mavi Y msAv I wwf b e dskb :GK-GK dskb, mweR dskb, GK GK mweR I weci x Z dsktbi D`vni Ymn Dc`vc b _vK te
9. GK-GK dskb, mweR dskb I GK-GK mweR dskb D`vni tYi mrvth` e`vL`v KiZ cvi te	<ul style="list-style-type: none"> weci x Z dskb Ašq I dsktbi tj LwP t 	<p>GLvfb tmU A I tmU B Gi ga` Ašq we`gvb wKŠ tWtgb I tKv tWtgb ci`ui cwi eZ0 Ki t j dskb I Ašq `BwUB nq-G avi Yvi gra`tg Dc`vc b </p> <ul style="list-style-type: none"> MwYwZK D`vni tYi mrvth` GK GK mweR dsktbi Av t j vPbv thgb-$f(x) = x + 1$ thLvfb x tRvo msL`v dskb wU GK-GK I mweR Ges GBifc dsktbi weci x Z dskb we`gvb c0E dsktbi tj LwP t Dj #`ti Lv t K GKvUgv t we` t Z t0` Ki t j dskb Ges GKvvaK we` t Z t0` Ki t j Ašq Gi e`vL`vi gra`tg Dc`vc b 	<ul style="list-style-type: none"> weci x Z dskb wY`q Ki t Y i mWkZv tj LwP t A w t i h _v`Zv dskb I Ašq kbr`K i tYi mWkZv 	<ul style="list-style-type: none"> $y = f(x) = mx + c, f(x) = ax^2 + bx + c$ 0v iv ewY Z dskb Ges $x^2 + y^2 = a^2$ 0v iv c0KwKZ Ašq i tj LwP t _vK te
10. weci x Z dskb e`vL`v KiZ cvi te				
g t b v t c w k R				
11. tj LwP t i mrvth` tKv t b v Ašq dskb wKbv Zv hvPvB KiZ cvi te				
12. Ašq I dsktbi tj LwP t Av b KiZ cvi te				

v0Zxq Aa`vq : exRMwvWZK i vnk

(12 vcv i qW)

vklbdj	velqe`	vklb-`tkLv`bv vbt` Rbv	gj`vqb vbt` Rbv	vetkl tj LK vbt` Rbv
<p>exRMwvWZK</p> <ol style="list-style-type: none"> euc`xi avi Yv e`vL`v Ki`Z cvi`te D`vni`Yi mrv`th` GK Pj K`v`nk`o euc`x e`vL`v Ki`Z cvi`te euc`xi `Y I fM e`vL`v Ki`Z cvi`te fM`tkl Dccv` I Drcv`K Dccv` e`vL`v Ges Zv c0qvM K`ti euc`xi Drcv`K vetkl`Y Ki`Z cvi`te mggw`l K i vnk, c0Zmg i vnk Ges Pμ-μvgK i vnk e`vL`v Ki`Z cvi`te mggw`l K i vnk, c0Zmg i vnk Ges Pμ-μvgK i vnk i Drcv`K vby`q Ki`Z cvi`te gj` fMusk`tk Avsuk`K fMusk`k cKvk Ki`Z cvi`te 	<ul style="list-style-type: none"> euc`x <ul style="list-style-type: none"> GK Pj K`v`nk`o euc`x euc`xi `Y I fM euc`xi Drcv`K vetkl`Y (fM`tkl Dccv` I Drcv`K Dccv`) mggw`l K, c0Zmg I Pμ-μvgK i vnk (Abp`Y`qZb Pj K) gj` fMusk`tk Avsuk`K fMusk`k cKvk (mij gj` fMusk) 	<ul style="list-style-type: none"> tefW`GKw euc`x thgb- $f(x) = ax^4 + bx^3 + cx^2 + dx + c$ wj`tl Gi gj`c`, mnM (gE` mnM), Pj K, a`teK I euc`xi gv`v Gi Avtj`vPbv fvrK, fvr`, fvmDj I fM`tkl e`envi K`ti $f(x) = P(x) Q(x) + R(x)$ Gi e`vL`v c0vb K`ti euc`x Drcv`tk vetkl`Y D`vni`Yi mrv`th` mggw`l K, c0Zmg, PμμvgK i vnk e`vL`v I Drcv`K vby`q 	<ul style="list-style-type: none"> gj`c`, mnM, Pj K a`teK I euc`xi gv`v vby`qKi`Yi mWkZv tk0Y A f`y`v mggw`l K, c0Zmg I PμμvgK i vnk vPw`y`ZKi`Yi mWkZv 	<ul style="list-style-type: none"> exRMwvWZK i vnk, c`, Pj K I a`teK i avi Yvi msu`y`B c`piv`vj`vPbv i gva`tg euc`x, GKPj`tki euc`x, euc`xi gv`v, gj`c`, a`teK I euc`xi Av`k`p`ci Dc`vcbv`vKte `B I wZb Pj`tki euc`x i vnk i D`vni`Ym e`vL`v`vKte D`vni`Yi mrv`th` fMm`f, mgZm`f, A`f`, fM`tkl I Drcv`K Dccv`i e`vL`v`vKte Drcv`K Dccv`i mrv`th` euc`xi Drcv`K vby`q Kivi tKSkj` i eY`v`vKte D`vni`Yi mrv`th` mggw`l K c0Zmg i vnk I PμμvgK i vnk i avi Yv Ges PμμvgK i vnk i Drcv`K vby`qi tKSkj``vKte D`vni`Yi mrv`th` gj` fMusk`k I Avsuk`K fMusk`k e`vL`v`vKte mij gj` fMusk`tk Avsuk`K fMusk`k cKv`tki tKSkj``vKte

ZZiq Aa`vq : mgxKiY (14 vciqW)

vklbdj	velqe`	vklb-`kLv`bv vbt` Rbv	gj`vqb vbt` Rbv	vetkl tj LK vbt` Rbv
<p>ep`e`Exq</p> <p>1. w0NvZ mgxKiY ($ax^2 + bx + c = 0$) mgvavb Ki`Z cvi`te </p> <p>2. eM@j`weikó mgxKiY wPw`yZ Ki`Z cvi`te </p> <p>3. eM@j`weikó mgxKiY mgvavb Ki`Z cvi`te </p> <p>4. mPKxq mgxKiY e`vL`v Ki`Z cvi`te </p> <p>5. mPKxq mgxKiY mgvavb Ki`Z cvi`te </p> <p>6. `B Pj`tki GKvZ I w0NvZ mgxKi`yi tRvU mgvavb Ki`Z cvi`te </p> <p>7. e`v`ewfiv`EK mgm`v`K `B Pj`tki GKvZ I w0NvZ mgxKi`y cKvk Kti mgvavb Ki`Z cvi`te </p> <p>8. `B Pj K`weikó mPKxq mgxKiY tRvU mgvavb Ki`Z cvi`te </p> <p>g`tbv`cukR</p> <p>9. tj LwP`ti mvrvt`h` w0NvZ mgxKiY ($ax^2 + bx + c = 0$) mgvavb Ki`Z cvi`te </p>	<ul style="list-style-type: none"> w0NvZ mgxKiY ($ax^2 + bx + c = 0$) mgvavb eM@j`weikó mgxKiY mPKxq mgxKiY `B Pj`K GKvZ I w0NvZ mgxKi`yi tRvU `B Pj K`weikó mPKxq mgxKiY tRvU tj LwP`ti mvrvt`h` w0NvZ mgxKiY mgvavb Ki`Z cvi`te 	<ul style="list-style-type: none"> eMxRi`yi gva`tg w0NvZ mgxKi`yi mgvavb ch`B D`vni`yi mvrvt`h` Dc`vcb w0NvZ mgxKiY mgvavb m`v`viY m`ti D`tj L`ceR e`vL`v Ges th`y`ti e`v`e gj`tbB Zvi I e`vL`v eM@j`weikó I mPKxq mgxKi`yi mgvavb c`Z ty`ti i`w`x cix`yi gva`tg hv`vB e`v`ewfiv`EK mgm`v`q `B Pj`tki GKvZ I w0NvZ mgxKi`y tRvU MVb I mgvavb e`vL`v $a(\neq 0), b, c$ Gi th`Kv`bv e`v`e g`v`bi Rb` tj LwP`ti mvrvt`h` w0NvZ mgxKiY mgvavb e`vL`v 	<ul style="list-style-type: none"> mgvavb I mgvavb i`w`x cix`yi i`w`xKi`yi mg`yZv mgxKiY MVb I mgvavb h`v`Zv tj LwP`t A`v`tbi h`v`Zv I mgvavb m`wKZv 	<ul style="list-style-type: none"> A`vZ e`v Pj i`wki c`piv`j vPbv`vKte w0NvZ mgxKiY ($ax^2 + bx + c = 0$) mgvavb tKSk`j i e`v`v`vKte eM@j`msev`j Z mgxKiY tRvU wPw`yZ Kivi Dc`vqi e`v`v`vKte D`vni`yi mvrvt`h` eM@j`msev`j Z mgxKi`yi mgvavb tKSk`j I i`w`x cix`yi`v`vKte mPK msev`j Z mgxKiY tRvU mgvavb tKSk`j D`vni`ymn e`vL`v`vKte `B Pj K`weikó GKvZ mgxKiY tRvU I w0NvZ mgxKi`y tRvU mgvavb D`vni`ymn e`vL`v`vKte e`v`ewfiv`EK mgm`v`K `B Pj`tki GKvZ I w0NvZ mgxKi`y cKvk`ki tKSk`j`vKte tj LwP`ti mvrvt`h` w0NvZ mgxKiY ($ax^2 + bx + c = 0$) mgvavb tKSk`j i e`v`v`vKte

PZL ©Aa`vq : R`wgvZ (10 wciqW)

wLbdj	welqe`	wLb-`tkLv`bv vb` Rbv	gj`vqb vb` Rbv	we`kl tj LK vb` Rbv
<p>ep`eE`xq</p> <p>1. j`A`wft`y`tc`i avi Yv`e`v`L`v` KitZ` cv`ite` </p> <p>2. wc`v`M`v`i`v`t`m`i Dccv`f`i` Dci w`f`w`E` K`ti` c`o`E` Dccv`f`i` t`j`v` c`o`v`Y` I` c`o`q`m` KitZ` cv`ite` </p> <p>3. w`l`f`r`i` c`w`i`k`>`a` f`i`k`>`a` I` j`A`e`>`y`m`a`u`K`Z` Dccv`f`i` t`j`v` c`o`v`Y` I` c`o`q`m` KitZ` cv`ite` </p>	<ul style="list-style-type: none"> • j`A`wft`y`c` • wc`v`M`v`i`v`t`m`i Dccv`f`i` we`v`z` <ul style="list-style-type: none"> o` t`j` t`k`v`Y` w`l`f`r`i` t`j` t`k`v`Y` wecixZ` ev`u`i` Dci Aw`v`Z` e`M`f`y`I` H` t`k`v`Y` m`i`b`m`Z` Ab`>`B` ev`u`i` I`ci Aw`v`Z` e`M`f`y`I` t`q`i` Ges` H` >`B`ev`u`i` t`h`k`v`b`v` G`K`u` I` Z`v`i` I`ci` Aci` ev`u`i` j`A` Awft`y`tc`i` A`S`M`Z` AvqZ`t`y`t`i` w`o`v`Y`i` m`g`w`i` m`g`v`b` o` t`h`k`v`b`v` w`l`f`r`i` m`z` t`k`v`Y`i` wecixZ` ev`u`i` I`ci` Aw`v`Z` e`M`f`y`I` Aci`>`B` ev`u`i` I`ci` Aw`v`Z` e`M`f`y`I` t`q`i` m`g`w`i` A`tc`y`v` H`>`B` ev`u`i` t`h`k`v`b`v` G`K`u` I` Z`v`i` I`ci` Aci`u`i` j`A` Awft`y`tc`i` A`S`M`Z` AvqZ`t`y`t`i` w`o`v`Y` c`w`i`g`v`Y` K`g` 	<ul style="list-style-type: none"> • Av`j` v`o`q`v`i` D`v`n`i`t`Y`i` m`v`r`v`t`h` j`A` Awft`y`tc`i` ev`e` avi Yv` c`o`v`b` Dccv`f`i`>`B`w` t`t`k` we`k`l` t`y`t` wc`v`M`v`i`v`t`m`i` m`f` c`o`Z`c`v`b` • w`l`f`r`i` ev`u`i` j`A`wft`y`tc`i`>`N` t`g`t`c` Dccv`f`i`i` welqe`>`h`v`P`v`B` • Dccv`f`i` t`j`v`i` e`enwi`K` c`o`q`m` D`v`n`i`t`Y`i` g`r`a`t`g` Dc`>`v`c`b` <p>w`P`I` G`t`K` c`w`i`k`>`a` f`i`k`>`a` I` j`A`e`>`y`e`v`L`v` </p> <p>G`K`K` K`v`R` :</p> <ul style="list-style-type: none"> o` m`g`t`i`L` we`>`y`w`Z`b`w` K`L`b` G`K`B` we`>`t`Z` w`g`v`j` Z` n`q` Z`v` w`b`a`f`i`Y` 	<ul style="list-style-type: none"> • w`P`I` m`w`K`f`v`t`e` j`A` Awft`y`c` w`P`y`Z`K`i`Y` • m`w`K`f`v`t`e` m`f` c`o`Z`c`v`b` • welqe`>`i` m`w`K`Z`v` h`v`P`v`B` <ul style="list-style-type: none"> • c`o`k`e`t`i`i` g`r`a`t`g` c`w`i`k`>`a` f`i`k`>`a` I` j`A`e`>`y` m`w`K`Z`v` h`v`P`v`B` • welqe`>`i` m`w`K`Z`v` • Dccv`f`i` c`o`q`m` h`v`>`Z`v` t`k`o`Y` Awf`y`v` 	<ul style="list-style-type: none"> • j`A`wft`y`tc`i` avi Yv`>`v`K`te` • wc`v`M`v`i`v`t`m`i` Dccv`f`i` Dci w`f`w`E` K`ti` c`o`E` Dccv`f`i` t`j`v` h`v`P`v`B` Kivi` c`o`h`v`R`b`x`q` K`v`h`e`g` I` Dccv`f`i` t`j`v`i` c`o`v`Y`>`v`K`te` <ul style="list-style-type: none"> • Dccv`f`i` t`j`v`i` e`enwi`K` c`o`q`m`i` D`v`n`i`Y`>`v`K`te` • Dccv`f`i` t`j`v` h`v`P`v`B` Kivi` c`o`h`v`R`b`x`q` K`v`h`e`g` I` Dccv`f`i` t`j`v`i` c`o`v`Y`>`v`K`te` • Dccv`f`i` t`j`v`i` e`enwi`K` c`o`q`m`i` D`v`n`i`Y`>`v`K`te`

wLbdj	wqlq`	wLb-`kLv`bv vbt` Rbv	gj`vqb vbt` Rbv	wtkl tj LK vbt` Rbv
<p>4. ep`_tBi Dccv`` cgvY l c0qM KiZ cri te </p>	<ul style="list-style-type: none"> o wlf`Ri tht`Kv`bv `B evui lci Aw4Z eMpyT`0tqi mgw0, ZZxq evui AtafKi lci eMpyT` Ges H evui mgw0LEK ga`gvi lci eMpyT`i mgw`-i w0_Y o wlf`Ri cwi`K`^; fi`K`^ l j`e`ymgtiL <p style="text-align: center;">ep`_tBi Dccv``</p> <ul style="list-style-type: none"> o tKv`bv wlf`Ri tht`Kv`bv `B evui AšMZ AvqZtyT` H wlf`Ri cwi`e`Ei e`vm Ges H evu0tqi mvaivY we`y t`_tK fvgi lci Aw4Z j`_t` AšMZ AvqZtyT`i mgvb 	<ul style="list-style-type: none"> • ep`_tBi Dccv`` l Utjvgi Dccv``i c0qM ev`E D`vni`Yi gva`tg Dc`icb 		<ul style="list-style-type: none"> • Dccv``_tjvi e`enwiK c0qM D`vniY_vKte • Dccv``_tjv hvPvB Kivi c0hvRbxq Kvhpig l Dccv``_tjvi cgvY_vKte • Dccv``_tjvi e`enwiK c0qM D`vniY_vKte
<p>5. Utjvgi Dccv`` cgvY l c0qM KiZ cri te </p>	<p style="text-align: center;">Utjvgi Dccv``</p> <ul style="list-style-type: none"> o e`E Ašlj`LZ tKv` PZf`Ri KY0tqi AšMZ AvqZtyT` H PZf`Ri weciX evu0tqi AšMZ AvqZtyT`i mgw0i mgvb 			

cĀg Aa'vq : R'wgvZK A¼b (12 wcnv qW)

wLbdj	velqe'	wLb-tkLvfbv vbt` Rbv	gj`vqb vbt` Rbv	wetkl tj LK vbt` Rbv
<p>eyxeEiq</p> <p>1. cĀ Ē Z_ I DcvĒEi wfvĒtZ wĪ fR A¼b Ges A¼tbi h_v_Zv hvPvB KiĒZ cviĒe </p>	<ul style="list-style-type: none"> • wewea R'wgvZK A¼b • wĪ fR mspvšl <ul style="list-style-type: none"> ○ wĪ fĒRi fvg, fvg msj Me GKwU tKvY I D"PZv t` I qv AvĒQ, wĪ fRwU A¼b KiĒZ nĒe ○ wĪ fĒRi fvg, wkiĒtKvY I Acievŭtqi mgwŭ t` I qv AvĒQ, wĪ fRwU A¼b KiĒZ nĒe ○ wĪ fĒRi fvg, wkiĒtKvY Ges AcĪ `Bewŭi Ašli t` I qv AvĒQ, wĪ fRwU A¼b KiĒZ nĒe ○ wĪ fĒRi D"PZv, fvgi Dci ga'gv Ges fvg msj Me GKwU tKvY t` I qv AvĒQ wĪ fRwU A¼b KiĒZ nĒe 	<ul style="list-style-type: none"> • R'wgvZK hšcvZi gva'tg tvtW[®] wĪ fR A¼b • jMZ KvR : wĪ fĒRi wZbwU wewfbocwĪ gvc t` I qv _vKĒj wĪ fRwU A¼b mæe wKbv-Zv hvPvB Ges AvĒj vPbv gva'tg wvxtšl DcbxZ nI qv 	<ul style="list-style-type: none"> • A¼tbi mwKZv • A¼tbi h_v_Zv • wvxtšli mwKZv 	<ul style="list-style-type: none"> • cĀ Ē Z_ I DcvĒEi wfvĒtZ wĪ fR A¼b Ges A¼tbi h_Ų_Zv hvPvB Gi eYŲv _vKĒe
<p>2. cĀ Ē Z_ I DcvĒEi wfvĒtZ eĒ A¼b Ges A¼tbi h_v_Zv hvPvB KiĒZ cviĒe </p>	<ul style="list-style-type: none"> • eĒ mspvšl <ul style="list-style-type: none"> ○ Ggb GKwU eĒ A¼b KiĒZ nĒe hv `BwU wvŲ Ų we>y w`Ēq hvq Ges hvi tK>`^a GKwU wvŲ Ų mij ĩi Lvq Aew`Z _vĒK 	<ul style="list-style-type: none"> • eĒ A¼b mspvšl Abkxj b 	<ul style="list-style-type: none"> • tkŲv AvfŲvi gva'tg A¼tbi mwKZv I h_v_Zv 	<ul style="list-style-type: none"> • cĀ Ē Z_ I DcvĒEi wfvĒtZ eĒ A¼b Ges A¼tbi h_Ų_Zv hvPvB Gi eYŲv _vKĒe

сĀg Aa`vq : R`wguZK A¼b (12 wci qW)

Pj gvb 2

wLbdj	weI qe`	wLb-¼kLv¼bv w¼t` Rbv	gj`vqb w¼t` Rbv	we¼kl tj LK w¼t` Rbv
	<ul style="list-style-type: none"> o GKwU wbw` ¼ ti Lv¼t¼ki mgvb e`vma¼e¼kó GKwU e¼ A¼b Ki¼Z n¼te hv` ¼wU wbw` ¼ we` yw` ¼q hvq o Gi¼c GKwU e¼ A¼b Ki¼Z n¼te hv GKwU wbw` ¼ e¼¼K wbw` ¼ we` ¼Z` úk¼K¼ti Ges e¼¼Ei ewnt` ¼¼K¼t¼bv wbw` ¼ we` yw` ¼q hvq o Gi¼c GKwU e¼ A¼b Ki¼Z n¼te hv GKwU wbw` ¼ mij ¼i Lv¼K GKwU wbw` ¼ we` ¼Z` úk¼K¼ti Ges ¼i Lvi ewnt` ¼¼K¼t¼bv we` yw` ¼q hvq 			

I ô Aa`vq : AmgZv (10 vciwqW)

wLbdj	velqe`'	wLb-tkLvfbv vbt` Rbv	gj`vqb vbt` Rbv	vetkl tj LK vbt` Rbv
<p>epxeEiq</p> <ol style="list-style-type: none"> 1. GK I `ß Pj tKi GK NvZwekó AmgZv e`vL`v Ki tZ cvi te 2. GK I `ß Pj Kwekó mij AmgZv MVb I mgvavb Ki tZ cvi te 3. ev`ewfvEK MmYwZK mgm`vq AmgZv e`envi Kti mgvavb Ki tZ cvi te <p>gibvvcikR</p> <ol style="list-style-type: none"> 4. GK I `ß Pj Kwekó AmgZvtK tj LvPt i mivvth` mgvavb Ki tZ cvi te 	<ul style="list-style-type: none"> • GK I `ß Pj tKi GK NvZwekó AmgZv <ul style="list-style-type: none"> ○ mij AmgZvi mgvavb ○ mij AmgZvi tj LvPt ○ ev`ewfvEK MmYwZK mgm`vq AmgZv e`envi 	<ul style="list-style-type: none"> • $x - a \leq b, x - a \geq b,$ RvZvq AmgZvi mgvavb c×wZ Dc`vcb • ev`ewfvEK mgm`vq AmgZvi e`vL`v MVb I mgvavb Dc`vcb • GK I `ß Pj Kwekó AmgZvtK tj LvPt Dc`vcb I mgvavb e`vL`v 	<ul style="list-style-type: none"> • AmgZv MVtb mÿgZv I mgvavb mWKZv • tj LvPt Avtbi h_v_Zv I mgvavb mWKZv 	<ul style="list-style-type: none"> • AmgZv I mgvavb cv`R` D`vni Ymn eYBv_vKte • RiebNwbó mgm`vq AmgZv e`envi Kivi tKSkjt i D`vni Ymn e`vL`v_vKte • GK I `ß Pj Kwekó AmgZvtK tj LvPt i mivvth` mgvavb Kivi tKSkj e`vL`v_vKte

mßg Aa`vq : Amxg aviv(7 vcnv qW)

wLbdj	velqe`	wLb-tkLvfbv vbt` Rbv	gj`vqb vbt` Rbv	vetkl tj LK vbt` Rbv
<p>epxeE`xq</p> <p>1. AbKtgi aviYv e`vL`v KitZ cvite </p> <p>2. Amxg aviv wPuyZ KitZ cvite </p> <p>3. Amxg ,tYvEi avivi mgwó _vKvi kZ`e`vL`v KitZ cvite </p> <p>4. Amxg ,tYvEi avivi mgwó wbyq KitZ cvite </p> <p>5. AveE``kngK msL`vK Abšl ,tYvEi avivq cKvk Ges mvaviY fMstK iJcvšli KitZ cvite </p>	<ul style="list-style-type: none"> • AbKtgi • Amxg aviv • Amxg ,tYvEi aviv • AveE``kngK msL`vK Abšl ,tYvEi avivq cKvk Ges mvaviY fMstK iJcvšli 	<ul style="list-style-type: none"> • tkvfbv Kvtk wkyv`x` i Avmb Abjvqx tivj b`f`_tjvi mgvštq mvrvtj GKw Abjvg cvl qv hvq GQrov tkvfbv tkvYi wkyv`x` i D`PZv mgvštq mvrvtj GKw Abjvg cvl qv hvq GB aitYi Avtiv D`vniY w`tq Abjvtgi Avtj vPbv • Abjvg I avivi gta` wj I Avj Dc`vcb • Amxg ,tYvEi aviv e`vL`v I mgwó wbyq i Avtj vPbv • D`vniYi gva`tg AveE``kngK msL`vK Abšl avivq cKvk Ges mvaviY fMstK iJcvšli 	<ul style="list-style-type: none"> • cOkwE`ti gva`tg velqe`i mWkZv • Abjvg I avivi cv`R` Kivi mYgZv • mgwó wbyq i mWkZv • tkvY AvfYvi gva`tg velqe`i mWkZv 	<ul style="list-style-type: none"> • Abjvg I avivi cv`R` D`vniYmn eYv`_vKte • Abjvg I avivi wv`c` tei Kivi tkškj D`vniYmn eYv`_vKte • Amxg ,tYvEi avivi mgwó wbyq Kivi c`wZmn eYv`_vKte • AveE``kngK i e`vL`v mn eYv`_vKte • D`vniYmn AveE``kngK msL`vK iJcvšli Kivi tkšktj i eYv`_vKte

Աճգ Աա՛վգ : ՝՝ փ՜ փ՜ ԿՅԳՅՅՅ

(22 յՅՅՅՅՅ)

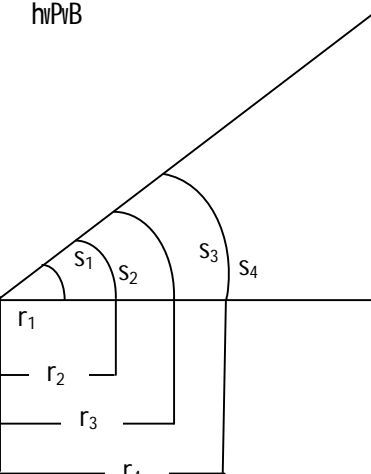
յՅՅՅՅՅ	յՅՅՅՅՅ	յՅՅՅՅՅՅՅՅ յՅՅՅՅՅ	գՅՅՅՅՅ յՅՅՅՅՅ	յՅՅՅՅՅ յՅՅՅՅՅ յՅՅՅՅՅ															
<p>ԵՅՅՅՅՅ</p> <ol style="list-style-type: none"> 1. յՅՅՅՅՅ յՅՅՅՅՅ յՅՅՅՅՅ յՅՅՅՅՅ յՅՅՅՅՅ յՅՅՅՅՅ 2. յՅՅՅՅՅ յՅՅՅՅՅ յՅՅՅՅՅ յՅՅՅՅՅ յՅՅՅՅՅ յՅՅՅՅՅ յՅՅՅՅՅ յՅՅՅՅՅ յՅՅՅՅՅ 3. յՅՅՅՅՅ յՅՅՅՅՅ յՅՅՅՅՅ յՅՅՅՅՅ յՅՅՅՅՅ յՅՅՅՅՅ յՅՅՅՅՅ յՅՅՅՅՅ յՅՅՅՅՅ 4. յՅՅՅՅՅ2π յՅՅՅՅՅ յՅՅՅՅՅ յՅՅՅՅՅ յՅՅՅՅՅ յՅՅՅՅՅ յՅՅՅՅՅ 5. $-\theta$ յՅՅՅՅՅ յՅՅՅՅՅ յՅՅՅՅՅ յՅՅՅՅՅ յՅՅՅՅՅ յՅՅՅՅՅ յՅՅՅՅՅ 6. յՅՅՅՅՅn ($n \leq 4$) յՅՅՅՅՅ ($\frac{n\pi}{2} \pm \theta$) յՅՅՅՅՅ յՅՅՅՅՅ յՅՅՅՅՅ յՅՅՅՅՅ յՅՅՅՅՅ 7. յՅՅՅՅ յՅՅՅՅՅ յՅՅՅՅՅ յՅՅՅՅՅ յՅՅՅՅՅ յՅՅՅՅՅ 	<ul style="list-style-type: none"> • յՅՅՅՅՅ յՅՅՅՅՅ • յՅՅՅՅՅ յՅՅՅՅՅ յՅՅՅՅՅ յՅՅՅՅՅ յՅՅՅՅՅ յՅՅՅՅՅ • յՅՅՅՅՅ յՅՅՅՅՅ յՅՅՅՅՅ յՅՅՅՅՅ յՅՅՅՅՅ • յՅՅՅՅՅ2π յՅՅՅՅՅ յՅՅՅՅՅ յՅՅՅՅՅ • $-\theta$ յՅՅՅՅՅ յՅՅՅՅՅ յՅՅՅՅՅ • յՅՅՅՅՅn ($n \leq 4$) յՅՅՅՅՅ ($\frac{n\pi}{2} \pm \theta$) յՅՅՅՅՅ յՅՅՅՅՅ յՅՅՅՅՅ • յՅՅՅՅ յՅՅՅՅՅ յՅՅՅՅՅ 	<ul style="list-style-type: none"> • յՅՅՅՅՅ յՅՅՅՅՅe ԱՅՅ յՅՅ յՅՅՅՅՅ յՅՅՅՅՅe յՅՅՅՅՅ յՅՅՅՅՅ յՅՅՅՅՅ յՅՅՅՅՅ • յՅՅՅՅՅ յՅՅՅՅՅ յՅՅՅՅՅ յՅՅՅՅՅ  <p>յՅՅՅՅՅ :</p> <table border="1" data-bbox="892 1006 1344 1153"> <thead> <tr> <th>ԵՅՅՅՅՅ</th> <th>ՍՅՅ (s)</th> <th>θ^c (ԵՅՅՅՅՅ)</th> </tr> </thead> <tbody> <tr><td> </td><td> </td><td> </td></tr> <tr><td> </td><td> </td><td> </td></tr> <tr><td> </td><td> </td><td> </td></tr> <tr><td> </td><td> </td><td> </td></tr> </tbody> </table> <p>[յՅՅՅՅՅ յՅՅ յՅՅ յՅՅ յՅՅ յՅՅ յՅՅ յՅՅ յՅՅ]</p> <ul style="list-style-type: none"> • յՅՅՅՅՅ յՅՅ յՅՅ յՅՅ յՅՅ յՅՅ 	ԵՅՅՅՅՅ	ՍՅՅ (s)	θ^c (ԵՅՅՅՅՅ)													<ul style="list-style-type: none"> • յՅՅ յՅՅՅՅՅ • յՅՅՅՅՅ յՅՅՅՅՅ յՅՅՅՅՅ • յՅՅՅՅՅ յՅՅՅՅՅ • յՅՅՅՅՅ յՅՅՅՅՅ 	<ul style="list-style-type: none"> • յՅՅՅՅՅ յՅՅՅՅՅ յՅՅՅՅՅ յՅՅՅՅՅ յՅՅՅՅՅ յՅՅՅՅՅ • յՅՅՅՅՅ յՅՅՅՅՅ յՅՅՅՅՅ • յՅՅՅՅՅ յՅՅՅՅՅ յՅՅՅՅՅ յՅՅՅՅՅ
ԵՅՅՅՅՅ	ՍՅՅ (s)	θ^c (ԵՅՅՅՅՅ)																	

beg Aa`vq : mPKxq I j Mwii`gxq dvskb (12 vciwqW)

vkLbdj	vel qe`	vkLb-tkLvfbv vbt` Rbv	gj`vqb vbt` Rbv	vetki tj LK vbt` Rbv									
<p>epxeE`xq</p> <ol style="list-style-type: none"> gj` mPK I Agj` mPK e`vL`v KiZ cvite gj` I Agj` mPKi Rb` wefboomf` c`vY I c`qM KiZ cvite mPK I j Mwii`tgi cvi`uwi K m`uR e`vL`v KiZ cvite j Mwii`tgi wefboomf` c`vY I c`qM KiZ cvite j Mwii`tgi wfvE` cwieZB` KiZ cvite mPKxq, j Mwii`gxq I ciggvb dvsktbi avi Yv e`vL`v KiZ cvite Ges mnR MwYwZK mgm`v mgravb KiZ cvite 	<ul style="list-style-type: none"> gj` I Agj` mPK mPK m`uwiKZ wefboomf` (gj` I Agj` mPKi Rb`) j Mwii`g <ul style="list-style-type: none"> $y = a^x, x = \log_a y$ j Mwii`tgi mfvewj mPKxq, j Mwii`gxq I ciggvb dvskb 	<ul style="list-style-type: none"> D`vniYi mvrth` gj` mPK I Agj` mPKi e`vL`v, c`vY I c`qM Dc`vcb $2^1 = 2, \log_2 2 = 1$ $2^2 = 4, \log_2 4 = 2$ $2^3 = 8, \log_2 8 = 3$ $2^4 = 16, \log_2 16 = 4$ GBfvte $y = a^x$ Ges $x = \log_a y$ Gi Dc`vcb D`vniYi gra`tg j Mwii`tgi wfvE` cwieZB`i Avtj vPbv $\text{thgb-} \log_{\frac{4}{3}} = \frac{\log_{10} 4}{\log_{10} 3} = \log_{10} 4 \times \log_3 10$ mPKxq, j Mwii`gxq I ciggvb dvsktbi e`vL`v Ges MwYwZK mgm`v mgravb Gt` i e`enrti i Avtj vPbv $2^x, e^x, \log x (\log_{10} x), \ln x, \log_e x, x$ Ges $x-1$ RivZiq dvsktbi tj LwPT A`b tcr`v/gw`vWqv BZ`w`Z Dch`p vel tq Dc`vcb wk`yK nrtZ Kjt Kvj Kjt Utii e`enrti vena t`Lvteb 	<ul style="list-style-type: none"> gj` I Agj` mPK wPwYwZKiY <p>QK ciY :</p> <table border="1"> <tr> <td>$3^1 = 3$</td> <td>$\log_3 3$</td> <td></td> </tr> <tr> <td></td> <td></td> <td></td> </tr> <tr> <td>$3^2 = 9$</td> <td>$\log_3 9$</td> <td></td> </tr> </table> <ul style="list-style-type: none"> tk`vY AvfvYv GZ` m`uwiKZ MwYwZK mgm`v mgravb mWwKZv tj LwPT A`b i h`v`Zv 	$3^1 = 3$	$\log_3 3$					$3^2 = 9$	$\log_3 9$		<ul style="list-style-type: none"> gj` Gi e`vL`v`vKte gj` fMusk mPK Ges Agj` mPK D`vni Ymn eY`v`vKte gj` mPK, avZwK cY` msvwL`K mPK, i`b` I avZwK cY` msvwL`K mPK Gi D`vni Ymn eY`v`vKte c`Zj tMi (antilog) we`vwi Z e`vL`v`vKte j tMi wfvE` cwieZB`i mfvE` c`vY I D`vni Y`vKte tWrtgb I ti`Amn mPKxq, j Mwii`gxq I ciggvb dvsktbi m`Av, tj LwPT, D`vni Y I c`qM`vKte K`vj Kjt Utii mvrth` j M I c`Zj M wY` Kivi Kvhpug A`stf`vKte
$3^1 = 3$	$\log_3 3$												
$3^2 = 9$	$\log_3 9$												
<p>gfbv`c`kR</p> <ol style="list-style-type: none"> mPKxq, j Mwii`gxq I ciggvb dvskb mgn`K tj LwPT i mvrth` Dc`vcb KiZ cvite K`vj Kjt Utii mvrth` j M I c`Zj M wY` KiZ cvite <p>Avtelxq</p> <ol style="list-style-type: none"> dvskbmgfni tj LwPT A`b AvMbx nte 	<ul style="list-style-type: none"> dvskbmgfni tj LwPT K`vj Kjt Utii mvrth` j M I c`Zj M wY` 	<p>GKK KvR K`vj Kjt Utii mvrth` j M I c`Zj M wY` Kiv </p>											

kg Aa`vq : w0c`x we`hZ

(07 wcnw qW)

wKLbdj	weIqe`	wKLb-ikLvfbv wbt`Rbv	gj`vqb wbt`Rbv	wetKI tj LK wbt`Rbv
<p>ep`eE`xq</p> <ol style="list-style-type: none"> 1. w0c`x we`hZ eY0v Ki}Z cvi}e 2. c`vm}Kj wI fR MVb Ki}Z cvi}e 3. `vfwEK msL`vi Nv}Zi Rb` w0c`x we`hZ eY0v Ki}Z cvi}e 4. n! I ⁿC_r Gi gvb wY0i Ki}Z cvi}e 5. w0c`x we`hZ e`envi K}i MwYwZK mgm`v mgvavb Ki}Z cvi}e 	<ul style="list-style-type: none"> • w0c`x we`hZ • c`vm}Kj wI fR MVb • mvariY Nv}Zi Rb` w0c`x we`hZ • n! I ⁿC_r Gi gvb • MwYwZK mgm`v mgvavb 	<ul style="list-style-type: none"> • (a + b)⁰, (a + b)¹, (a + b)² Ges (a + b)³ Gi we`hZi K}i mnM₂ tj vi gva}tg c`vm}Kj wI fR MVb GKBfv}e cieZx`gvI vi we`h}i i Av}j vPbv • D`vnt}Yi gva}tg n! I ⁿC_r Gi gvb wY0i e`vL`v • MwYwZK mgm`v mgvav}b w0c`x we`hZ e`env}i i Av}j vPbv 	<ul style="list-style-type: none"> • c`vm}K}j i wI fR m}I i mnv}th` w0c`x we`h}i i mnM wY0i m}ygZv • gvb wY0i m}wKZv • mgvav}bi m}wKZv 	<ul style="list-style-type: none"> • w0c`x we`hZi eY0v _vK}e • c`vm}Kj wI fR MV}bi e`vL`v _vK}e • mvariY Nv}Zi Rb` w0c`x we`hZ eY0v _vK}e (n≤8) • n! I ⁿC_r Gi gvb wY0i _vK}e n `vfwEK msL`v (n≤8)

GKv`k Aa`vq : `vbr¼ R`vugvZ (12 vcvu qW)

vklbdj	velqe`	vklb-iklvbvr vbt` Rbv	gj`vqb vbt` Rbv	vetkl tj LK vbt` Rbv																																			
<p>ev`eEiq</p> <p>1. mgZtj KvZm¼q `vbr¼i avi Yv e`vL`v KiZ cvi te </p> <p>2. `BvU ve`j ga`eZr`i Zi wbyq KiZ cvi te </p>	<ul style="list-style-type: none"> mgZtj KvZm¼q `vbr¼ `BvU ve`j ga`eZr`i Zi 	<ul style="list-style-type: none"> D`vni`vi mvrth` mgZtj thgb tUvej, eovKteW^q KvM`Ri Dci ci`ui `BvU j vj w`ti Lv tUtb Ay I PZfvMⁱ avi Yv Ges wefbae PZfvM ve`j cvZb Mödtccvti/MödtterfW^p mvrth` mgZtj thgb KvZb `BvU ve`j `i Z`K GKvU mgtKvYx w` f`Ri AvZfR vnrvtete vetePbv Kti Gi %N`wbyq <p>GKK KvR: OK ciY</p> <table border="1" data-bbox="886 768 1344 967"> <thead> <tr> <th>(x₁,y₁)</th> <th>(x₂,y₂)</th> <th>(x₂,x₁)</th> <th>(y₂,y₁)</th> <th>ve`y `BvU `i Zi</th> </tr> </thead> <tbody> <tr> <td>(2,1)</td> <td>(2,3)</td> <td></td> <td></td> <td></td> </tr> <tr> <td></td> <td></td> <td></td> <td></td> <td></td> </tr> <tr> <td></td> <td></td> <td></td> <td></td> <td></td> </tr> </tbody> </table>	(x ₁ ,y ₁)	(x ₂ ,y ₂)	(x ₂ ,x ₁)	(y ₂ ,y ₁)	ve`y `BvU `i Zi	(2,1)	(2,3)														<ul style="list-style-type: none"> Mötd cwZZ ve`yt`tk Aymn fR I tKvU wPvYZ Kivi mygZv wefbaePZfvM ve`j cvZtbi mWvKZv ve`j cvZtbi h_v`Zv Mödtccvti mgtKvYx w` f`R AvZtbi h_v`Zv ve`y `BvU `i Zi wbyq mWvKZv <p>OK wbyq :</p> <table border="1" data-bbox="1369 816 1648 998"> <thead> <tr> <th>(x₁, y₁)</th> <th>(x₂, y₂)</th> <th>Xvj</th> </tr> </thead> <tbody> <tr> <td>(1,1)</td> <td>(2,2)</td> <td></td> </tr> <tr> <td>(-1,2)</td> <td>(-2,3)</td> <td></td> </tr> <tr> <td>(-2,-3)</td> <td>(-3,-4)</td> <td></td> </tr> <tr> <td>(2,-3)</td> <td>(3,-4)</td> <td></td> </tr> </tbody> </table>	(x ₁ , y ₁)	(x ₂ , y ₂)	Xvj	(1,1)	(2,2)		(-1,2)	(-2,3)		(-2,-3)	(-3,-4)		(2,-3)	(3,-4)		<ul style="list-style-type: none"> mgZtj ve`j Ae`vb wbyq i tKStj i eY^q _vKte `BvU ve`j ga`eZr`i Zi wbyq m` _vKte
(x ₁ ,y ₁)	(x ₂ ,y ₂)	(x ₂ ,x ₁)	(y ₂ ,y ₁)	ve`y `BvU `i Zi																																			
(2,1)	(2,3)																																						
(x ₁ , y ₁)	(x ₂ , y ₂)	Xvj																																					
(1,1)	(2,2)																																						
(-1,2)	(-2,3)																																						
(-2,-3)	(-3,-4)																																						
(2,-3)	(3,-4)																																						
<p>3. mij`tiLvi Xvj i avi Yv e`vL`v KiZ cvi te </p>	<ul style="list-style-type: none"> mij`tiLvi Xvj I mgxKiY 	<ul style="list-style-type: none"> ev`et`y`i Xvj i avi Yv- thgb iv`li Xvj, wUtb i Pvj i Xvj, cKa cvtoi Xvj, w`cvf`i Xvj, vnrvti Xvj BZ`w`i mvrth` Xvj i avi Yv e`vL`v Xvj wbyq <ul style="list-style-type: none"> Dj w` K `i Zi I AvbfugK `i Zi gva`tg Xvj = DV(rise)/nvlv(run) Xvj = $\tan\theta = \frac{y_2 - y_1}{x_2 - x_1}$ 		<ul style="list-style-type: none"> `BvU ve`j msthM tiLvi Xvj wbyq m` _vKte `BvU ve`j msthM MvZ mij`tiLvi mgxKiY I mgxKiY t`tk Xvj I tO`K wbyq _vKte 																																			

wLbdj	vel qe`´	wLb-tkLvfbv wbt` Rbv	gj`vqb wbt` Rbv	we`tkl tj LK wbt` Rbv
<p>4. mij ti Lvi mgxKiY wbyq KitZ cvi te </p> <p>5. `vbw¼i gva`tg wlftri tyidj wbyq KitZ cvi te </p> <p>6. evui `N°wbyqi gva`tg wlfri PZfRi tyidj wbyq KitZ cvi te </p> <p>gibv`cukR</p> <p>7. we`pvczbi gva`tg wlfri PZfR mspvsi R`wgvZK A¼b KitZ cvi te </p> <p>8. mij ti Lvi mgxKiY tj LwPti Dc`vcb KitZ cvi te </p>	<ul style="list-style-type: none"> • wlfri PZfRi tyidj • wlfri PZfR A¼b • mij ti Lvi tj LwPti 	<ul style="list-style-type: none"> • gj we`Mvgx mij ti Lvi mgxKiY $y = mx + c$ Avkti cKvk Ges $y = mx + c$ mgxKiY wbyqi Avtj vPbv • wlfri tyidj i mrvth` euftri tyidj (2,2),(4,3),(5,5),(3,7) i (-1,5) we`y,tj vk mgZtj cvZb Kti Drcbe R`wgvZK tyidj i tyidj • weifbPZfRM we`pvczbi Kti wlfri PZfR tyidj i tyidj • mgxKiY $y=0$ emtq x Atyi Dci tkvfbv we`yubtq Ges $x=0$ emtq Y Atyi Dci we`yubtq Ges we`yubtq thvM Kti tj LwPti mij ti LwUtk t`Lvfbv 	<ul style="list-style-type: none"> • Xvj wbyqi h_v_Zv • A4tbi h_v_Zv Ges tyidj wbyqi mwKZv • A4tbi h_v_Zv 	<ul style="list-style-type: none"> • wZbu we`y mrvth` MVZ wlfri tyidj wbyqi Rb` $tyidj = \frac{\sqrt{s(s-a)(s-b)(s-c)}}{m}$ m f Oviv gvb wbyq vKte

Øv`k Aa`vq : tf±i (10 vciqW)

wLbdj	velqe`	wLb-tkLv`bv wbt`Rbv	gj`vqb wbt`Rbv	wetkI tj LK wbt`Rbv
<p>ey`eE`vq</p> <p>1. t`jvi iwkl tf±i iwkl eYØv KitZ cvi`te </p> <p>2. t`jvi iwkl tf±i iwkl cØxtKi mrvth` e`vL`v KitZ cvi`te </p> <p>3. mgvb tf±i, wecixZ tf±i I Ae`vb tf±i e`vL`v KitZ cvi`te </p> <p>4. tf±ii thvM I thvMwewa e`vL`v KitZ cvi`te </p> <p>5. tf±ii wetqvM e`vL`v KitZ cvi`te </p> <p>6. tf±ii t`jvi `wYZK I GKK tf±i e`vL`v KitZ cvi`te </p> <p>7. tf±ii t`jvi `wYZK I eUbwewa e`vL`v KitZ cvi`te </p> <p>8. tf±ii mrvth` weifbe R`wgnZK mgm`vi mgvavb KitZ cvi`te </p>	<ul style="list-style-type: none"> t`jvi iwkl tf±i iwkl mgvb tf±i, wecixZ tf±i I Ae`vb tf±i tf±i thvM I thvMwewa tf±ii t`jvi `wYZK I GKK tf±i weifbe R`wgnZK mgm`vi 	<ul style="list-style-type: none"> chfB D`vni`Yi mrvth`, thgb-Kv`k QvT`i msL`v MYbv Kti th mKj iwkl, t`jv cvl qv tMj Zv t`jvi Ges Kv`k iag t`tK c`vb wky`tKi ig chS`i t`Zi mvt`w`K h`p`vKvq H`i`Zi wbt`RK iwkl n`tjv miY hv GKwU t`fKUi GKBfite Zvcgv`v, mgq, fi BZ`w` t`jvi iwkl Ges teM, ZiY, I Rb BZ`w` tf±i iwkl wmvte Dc`vcb wP`I D`vni`Yi mrvth` mgvb tf±i, wecixZ tf±i I Ae`vb tf±ii e`vL`v tKv`bv tf±i `u` tK i` Ges j` Gi gva`tg cKv`k thgb- `u`=a`i+ b`j` mgv`S`ni K I w`i`fR m`f`I mrvth` thvM I thvMwewa e`vL`v Ges D`vni`Yi mrvth` Av`j vPbv t`jvi `wYZK gj` msL`v (kb`, aYvZK, FYvZK I fMusk) Øviv `Ymga wP`I mrvth` Dc`vcb 	<ul style="list-style-type: none"> t`jvi I tf±i wPv`YZKiY wP`I mrvth` mgvb tf±i, wecixZ tf±i I Ae`vb tf±i Ae`vb tf±i wY`qi m`ygZv thvMwewa cØqv`Mi m`ygZv t`jvi `YtK wP`I Dc`vcb Kivi m`ygZv 	<ul style="list-style-type: none"> t`jvi iwkl tf±i iwkl eYØv I cØxtKi mrvth` e`vL`v `vKte wP`I D`vni`Yi mrvth` mgvb tf±i, wecixZ tf±i I Ae`vb tf±ii e`vL`v `vKte wP`I mrvth` tf±i thvM I thvMwewa m`gn`i (weibgg wewa, mst`hvM wewa) e`vL`v `vKte tf±ii t`jvi `wYZK, eEbwewa I GKK tf±ii e`vL`v `vKte tf±ii mrvth` thb weifbe R`wgnZK mgm`vi mgvavb KitZ cvi`ti tmRb` cØqvRbxq Kv`h`ig `vKte

Îtq̄v` k Aa`vq : Nb R`wgvZ (14 wcviqW)

wLbdj	wēl qe`	wLb-ŋkLvŋv wbt` Rbv	gj`vqb wbt` Rbv	wētkl tj LK wbt` Rbv
<p>ew̄eĒxq</p> <p>1. Nbe`-i cĀxKxq wPĀ A¼b KiŋZ cviŋe </p> <p>2. wĀRg, wciwgv AvKwZi e`-j tMj K l mgeĒfvgK tKvYŋKi AvqZb Ges cĀZŋj i tŷĀdj wYŋ KiŋZ cviŋe </p> <p>3. Nb R`wgvZi aviYv cĀqM Kŋi mgm`v mgravŋb KiŋZ cviŋe </p> <p>gŋbŋcwkR</p> <p>4. thšwMK Nbe`-i AvqZb Ges cĀZŋj i tŷĀdj cwigvc KiŋZ cviŋe </p> <p>5. Nb R`wgvZi aviYv e`enwi K tŷĀ cĀqM KiŋZ cviŋe </p>	<ul style="list-style-type: none"> Nb R`wgvZi tgsŋj K aviYv AvqZKvi Nbe`-i NbK wĀRg, wciwgv, tMj K, l mgeĒfvgK tKvYŋKi AvqZb Ges cĀZŋj i tŷĀdj ev`-e mgm`v thšwMK Nbe`-i AvqZb Ges cĀZŋj i tŷĀdj cwigvc 	<ul style="list-style-type: none"> wewfbaNbe`-i bgŋv cĀ kĀ Kŋi wkyv_xŋ i ŷYe`-i mvŋ_ cwĀ wPZ Kiv Ges Zŋt` i cĀxwK wPĀ A¼ŋbi mrvŋth` Avŋj vPbv KwMR l KkxŋUi mrvŋth` Nbe`-`Zwi Kŋi tm_tjvi tŷĀdj l AvqZb wYŋqĀi Avŋj vPbv ev`-e tŷĀŋ Nb R`wgvZi cĀqM Kŋi wewfbaŋgm`v mgravŋbi Avŋj vPbv ŋŋw e`-i mrvŋth` Aci GKw Nbe`-i ŋZwi Kŋi Gi AvqZb l cĀZŋj i tŷĀdj wYŋqĀi Avŋj vPbv: thgb-` i Rvi Dcŋi i Ask Aa`Mj vKvi Ges ewk Ask AvqZKvi <p>GKK KvR/tRvovq KvR</p> <ul style="list-style-type: none"> tcbwvj, tgvgewZ, tKvb AvKwZi Nbe`-i cĀZŋj i tŷĀdj l AvqZb cwigvc mŋg KwŋPi tevZj hvi wbt`Pi fVM wmvj Ūvi vKwZ l Dcŋi i fVM tKvYvKwZ Gi AvqZb cwigvc GKw Kvwŋbi Dci GKw dŋej tiŋL Gi dukv Astki AvqZb cwigvc 	<ul style="list-style-type: none"> Nbe`-i wPwYZKi Y l bgŋv wPĀ A¼ŋb mŷgZv Nbe`-i tŷĀdj AvqZb wYŋqĀi KiŋYi mwKZv mgm`v mgravŋbi mwKZv thšwMK Nbe`-i AvqZb l cĀZŋj i tŷĀdj wYŋqĀi KiŋYi mwKZv AvqZb wYŋqĀi KiŋYi mwKZv 	<ul style="list-style-type: none"> Nbe`-i cĀxKxq wPĀ A¼ŋbi tKŋj _vKŋe ev`-e D`vni Y l wPĀ i mrvŋth` wĀRg, wciwgv AvKwZi e`-Zi, mgeĒfvgK tKvYK l tMj tKi tŷĀdj Ges AvqZb wYŋqĀi tKŋj _vKŋe wkyv_xŋv thb nvŋZ-Kj tgv wĀRg, wciwgv AvKwZi e`-Zi mgeĒfvgK tKvYK l tMj tKi tŷĀdj Ges AvqZb wYŋqĀi KiŋZ cviŋi Zvi cĀqvRbxq Kvŋŋg Ašfŋ _vKŋe

PZi R Aa'vq : mtebv (08 vci qW)

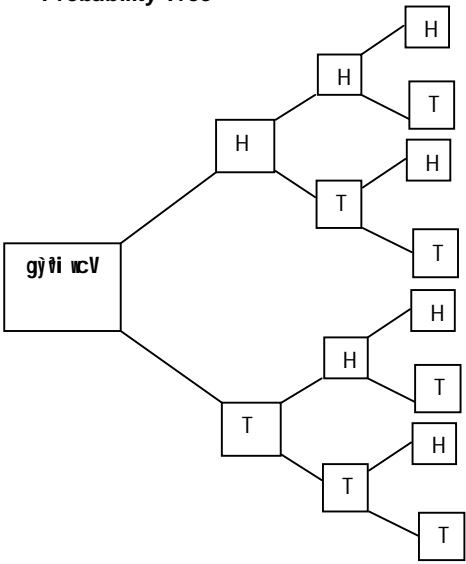
wLbdj	velqe'	wLb-ikLv'bv vbt' Rbv	gj'vqb vbt' Rbv	vetki tj LK vbt' Rbv
<p>ep'e'iq</p> <ol style="list-style-type: none"> mtebvi avi Yv e'vL'v KiZ cvi te %bw`b weifbaD`vni tYi mnvth` wvOZ NUbv, Amte NUbv I mte` NUbv eYbv KiZ cvi te GKB NUbvi cpive'E NUtj mte` djvdj wYq (gj' I Q°vi mnvth`) GKB NUbvi cpive'E NUtj mtebv wYq KiZ cvi te 	<ul style="list-style-type: none"> mtebvi I Gi e'envi <ul style="list-style-type: none"> mtebvi avi Yv wvOZ NUbv, Amte NUbv, mte` NUbv GKB NUbv Aba'wZbevi cpive'E NUtj djvdj wYq (gj' I Q°vi mnvth`) mnR I ev'ewfiEK mgm'vi mgvavb 	<ul style="list-style-type: none"> cOZw` tbi AvenvI qv evZ' tLj vq nvi wRtZi mtebv BZ'w` i mnvth` mtebvi avi Yv Dcörcb mth' q, mth' l, w` bi w' BZ'w` i mnvth` wvOZ NUbv I Amte NUbvi e'vL'v cOvb jYi Q°vi mnvth` mte` NUbv Dc`rcb GKB NUbvi Aba'wZbevi cpive'E NUtj mte` djvdj <p>gj' vbt' tci mnvth` Probability Tree MVtbi gra'tg Dc`rcb</p> <p>Probability Tree</p> 	<ul style="list-style-type: none"> tgwLKfvte e'vL'v cOvtbi mWKZv mWKfvte weifbaNUbv mbv³KiY 	<ul style="list-style-type: none"> D`vni tYi mnvth` mtebvi avi Yvi eYbv _vKte %bw`b weifbaD`vni tYi mnvth` wvOZ NUbv, Amte NUbv I mte` NUbv eYbv _vKte gj' I Q°vi mnvth` GKB NUbvi Aba'wZbevi cpive'E NUtj mte` djvdj I mtebv wYq i eYbv _vKte

wLbdj	velqe'	wLb-ikLvfbv vbt` Rbv	gj`vqb vbt` Rbv	vetki tj LK vbt` Rbv												
<p>5. mtebvi mnR I ev`ewfiEK mgm'vi mgvavb Ki tZ cvi te </p>	<p>o mnR I ev`ewfiEK mgm'vi mgvavb</p>	<p>GKK KvR Dctii Probability Tree Gi mnvth` vbtPi OKuJ GtY</p> <table border="1" data-bbox="919 451 1339 812"> <thead> <tr> <th data-bbox="919 451 1031 516">gj` vbt`yc</th> <th data-bbox="1031 451 1184 516">mKj mte` dj vdj</th> <th data-bbox="1184 451 1339 516">mtebv</th> </tr> </thead> <tbody> <tr> <td data-bbox="919 516 1031 613">GKevi gj` vbt`yc</td> <td data-bbox="1031 516 1184 613"></td> <td data-bbox="1184 516 1339 613">P[T] =</td> </tr> <tr> <td data-bbox="919 613 1031 711">`bevi gj` vbt`yc</td> <td data-bbox="1031 613 1184 711"></td> <td data-bbox="1184 613 1339 711">P[HT] =</td> </tr> <tr> <td data-bbox="919 711 1031 812">wZbevi gj` vbt`yc</td> <td data-bbox="1031 711 1184 812"></td> <td data-bbox="1184 711 1339 812">P[HHT] =</td> </tr> </tbody> </table> <p>gj` I Q°vi mnvth` GKB NUbvi AbaY® wZbevi cpivevE NUtj mte` dj vdj I mtebv vbtYq Kite Ges GtK Actii LvZv gj`vqb Kite</p>	gj` vbt`yc	mKj mte` dj vdj	mtebv	GKevi gj` vbt`yc		P[T] =	`bevi gj` vbt`yc		P[HT] =	wZbevi gj` vbt`yc		P[HHT] =	<ul style="list-style-type: none"> • mte` dj vdj vbtYq miWKZv • mtebv vbtYq vbtYq Zv 	
gj` vbt`yc	mKj mte` dj vdj	mtebv														
GKevi gj` vbt`yc		P[T] =														
`bevi gj` vbt`yc		P[HT] =														
wZbevi gj` vbt`yc		P[HHT] =														

5. tj LK wbt` Rbv

beg`kg tkvvi D`PZI MvYZ welqiu Rb` 100 baf eivi ivLv ntqtQ| mBrtn 3 wJ Kti 2 eQti tgvU 216 wJ wciwqW eivi ivLv ntqtQ| cOZwU wciwqW mgq 50wgbU| D`PZIMvYZ wltqi wkyvutg wLbdj Ges wltqe` Ggbfite cVqb Kiv ntqtQ thb eivi KZ wciwqW wkyv_xPv me_tjv wLbdj ARB KitZ cvti | D`PZI MvYZ welqiu beg` kg tkvvi weAvb kvLvi wkyv_xt`i Rb` GKwU bevPwbK wltq| D`PZI MvYZ wltq GKwU cv`cy`K mpcwi k Kiv ntqtQ| cv`cy`K mpcwi kKZ cpvmsL`v ntjv (300±20)cpv|

cv`cy`K i Pbv t`yt` wbt` wLZ wltqmgfni cOZ mwtkl _iazjw`tZ nte-

- wkyvKtg ewYZ mpcw`B wLbdj Ges wLb-tkLvtbv wbt` Rbv wetePvbiq titL wltqe` Dc`vcb KitZ nte|
- cOhr` t`yt` Aa`e`b chiq wltqe` Dc`vcb KitZ nte| Dc`vcbi iwZ nte mnR t`tK KwB, Rbv t`tK ARbv I gZ`t`tK wegZ` wltqe` Dc`vcb avivmnKZv eRvq ivLtz nte Ges wkyv_xPv i eqm, gvbwmK cwicKZv I aviY jgZv Dc`thvMx Kti mnR I Puj Z fvlvq wj LtZ nte|
- wltqe` Dc`vcb cOhr` D`vniY e`envi KitZ nte| cOZ Aa`vtq cOmwK I RxebrfweK D`vniY cv`cy`K msthvRb KitZ nte| Abkxj bxtZ Dc`wcz mgm`vmgv PPPQvovl wkyv_xPv wPst` I aviYvi thb weKvk NtU tmw`tK tLqj ivLtz nte| Dc`wcz D`vniY I Abkxj bxi KvRmgv wkyv_xPv i `bw`b Rxe`bi Ges AwRZ AvfAZvi mt`_ Aek`B m`uK`p nte|
- AvteMxq wLbdj AR`bi Rb` wltqe` Dc`vcb ev`brfweK mgm`v I KgRvD msthvRb KitZ nte|
- wltqe`i Dc`vcb KgRvDwRfweK nte| Dc`wcz wltqe` AvKl`vq I Avb`v`vqK Kivi Dci _iazj`cOvb KitZ nte, hvtz MvYZ wkyvi cOZ wkyv_xPv i Avbnv I fvwz`t`nq|
- Aa`vq tktl cOhr`t`yt` e`envi tKi Rb` Kvh`ug msthvRb KitZ nte|
- wLbdj AR`bi Rb` chfB Abkxj bxi w`tZ nte Ges Abkxj bxtZ mRbKxj cOke msthvRb KitZ nte|
- wkyv_xPv epxeExq weKvk mnvqK mgm`v msthvRb KitZ nte| wkyv`Kti b`bZg mnvqZvq hvtz wkyv_xPv wltqe` AvqE KitZ cvti thw`tK Zxye`w`w`tZ nte|
- w`vj qvfwEK gj`vq`bi Dc`thvMx KgRvDwRfweK wltqe` (activity based content) cv`cy`K msthvRb KitZ nte|
- wltqe` Dc`vcb tRUVi mgZv (gender equity) i`yv KitZ nte|
- wltqe` Dc`vcb %wZK gj`tetai cwicSk I agv` AbfjZtZ AvNvZ nvtb Ggb wltq cwi nvi KitZ nte|



জাতীয় শিক্ষাক্রম ও পাঠ্যপুস্তক বোর্ড, ৬৯-৭০, মতিঝিল বাণিজ্যিক এলাকা, ঢাকা-১০০০